



## The 2012 Audi A6 Vehicle Introduction



Audi of America, LLC  
Service Training  
Printed in U.S.A.  
Printed 4/2011  
Course Number 990613

©2011 Audi of America, LLC

All rights reserved. Information contained in this manual is based on the latest information available at the time of printing and is subject to the copyright and other intellectual property rights of Audi of America, LLC., its affiliated companies and its licensors. All rights are reserved to make changes at any time without notice. No part of this document may be reproduced, stored in a retrieval system, or transmitted in any form or by any means, electronic, mechanical, photocopying, recording or otherwise, nor may these materials be modified or reposted to other sites without the prior expressed written permission of the publisher.

All requests for permission to copy and redistribute information should be referred to Audi of America, LLC.

Always check Technical Bulletins and the latest electronic service repair literature for information that may supersede any information included in this booklet.

# Table of Contents

<b>Introduction</b> . . . . .	<b>1</b>
<b>Body</b> . . . . .	<b>2</b>
Exterior Dimensions . . . . .	2
Overview . . . . .	4
<b>Occupant Protection</b> . . . . .	<b>6</b>
Introduction . . . . .	6
<b>Engine</b> . . . . .	<b>11</b>
3.0L V6 TFSI Engine . . . . .	11
Innovative Thermal Management . . . . .	13
ATF Heating / Cooling . . . . .	14
2.0L TFSI Engine . . . . .	16
ATF Cooling . . . . .	18
<b>Power Transmission</b> . . . . .	<b>20</b>
Overview . . . . .	20
<b>Suspension System</b> . . . . .	<b>22</b>
Overview . . . . .	22
Axles . . . . .	23
Electromechanical Steering . . . . .	24
Brake System . . . . .	25
ESP . . . . .	26
Audi Drive Select . . . . .	27
<b>Electrical System</b> . . . . .	<b>28</b>
Power Supply Overview . . . . .	28
Fuses and Relays . . . . .	29
Control Module Locations . . . . .	30
Topology . . . . .	32
Exterior Lighting . . . . .	34
Headlights . . . . .	36
Rear Lights . . . . .	47
Rear Lights at Night . . . . .	48

# Table of Contents

<b>Climate Control</b> .....	<b>50</b>
Overview .....	50
<b>Infotainment</b> .....	<b>51</b>
Introduction .....	51
Topology .....	51
Radio Media Center (RMC) .....	52
MMI Radio Plus (RMC) .....	53
MMI Navigation Plus .....	54
Google Earth Mapping .....	56
WLAN Hotspot .....	57
Operating Unit .....	59
MMI Display .....	60
MMI Display Swivel Mechanism .....	61
Sound Systems .....	62
Antenna Overview .....	64
<b>Head-Up Display</b> .....	<b>65</b>
Introduction .....	65
Display Information .....	66
Windshield Projection Display Control Module J898 .....	68
<b>Self-Study Programs for the 2012 Audi A7</b> .....	<b>72</b>
<b>Knowledge Assessment</b> .....	<b>73</b>

The Self-Study Program provides introductory information regarding the design and function of new models, automotive components, or technologies.

**The Self-Study Program is not a Repair Manual!**  
**All values given are intended as a guideline only.**

For maintenance and repair work, always refer to current technical literature.

Reference



Note



# Introduction

The lineage of the Audi A6 sedan begins in the late 1960s with the launch of the Audi 100. The impact of the Audi 100 was revolutionary, embodying what was to become a new innovative spirit for the Audi brand.

With its classic, uncluttered design, the Audi 100 formed the cornerstone for many legendary Audi C-platform vehicles that would emerge in the 1970s, '80s, and '90s, each leaving a lasting mark and forecasting the future.

In the process, the Audi 100 became the Audi A6. Through it all, timeless and innovative Audi design cues and technology redefined automotive elegance and sportiness for each new decade.

The 2012 Audi A6 continues this tradition. Its Audi internal designation is C7, being the seventh generation of the company's C-platform. Like its predecessors, the C7 design inspires and creates enthusiasm.

The new Audi A6 is a remarkable sedan that blends comfort and sport characteristics seamlessly. It is both a practical car and a car that excites every time you turn the wheel. Many of the A6's technology and comfort features have only been available previously in luxury class vehicles.

What the Audi 100 began, the new Audi A6 takes to new levels.



486\_064

# Body

## Exterior Dimensions

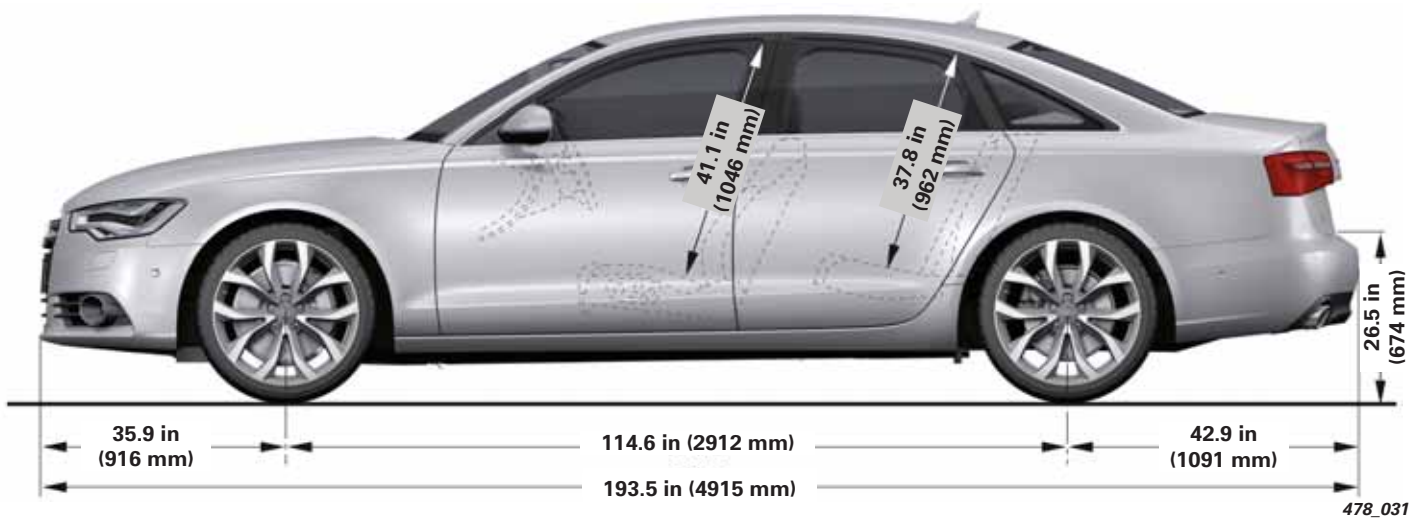
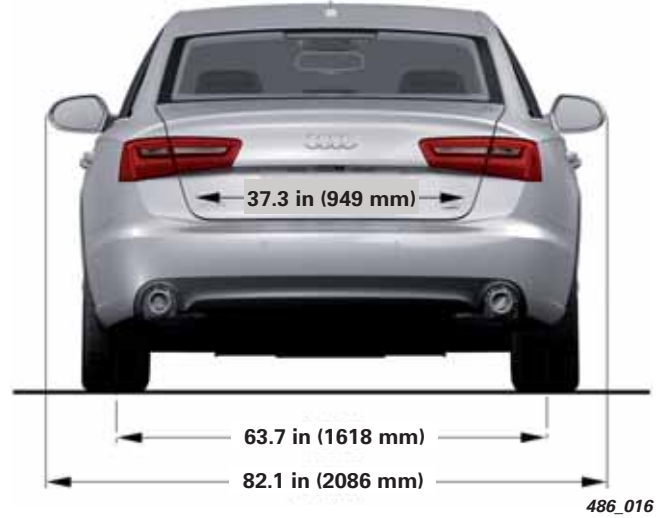
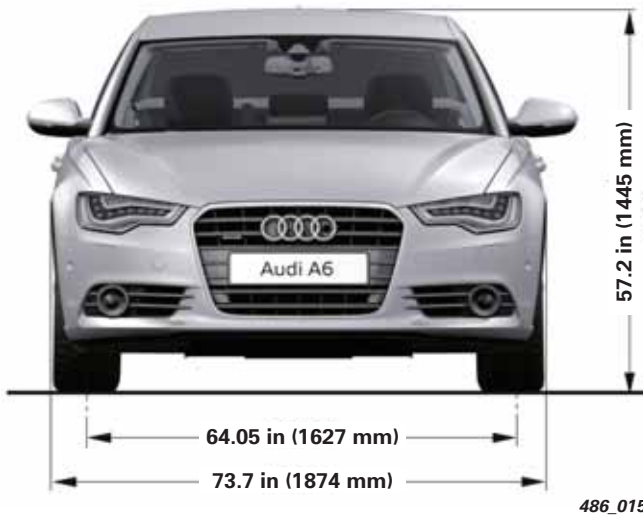

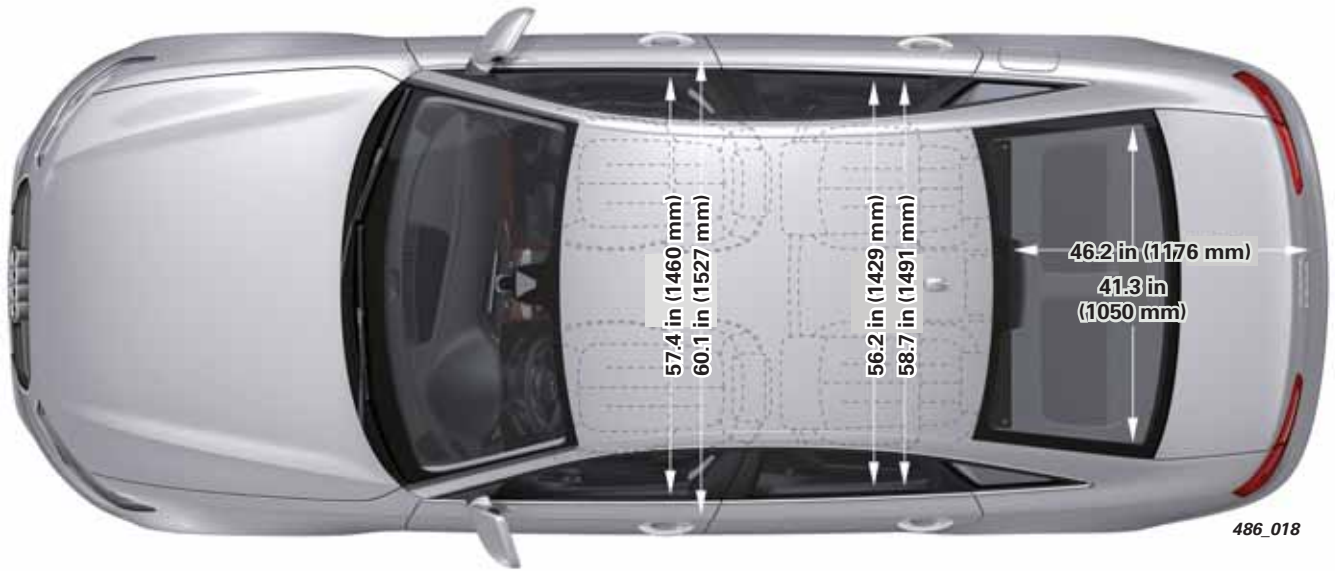

Length	193.5 in (4915 mm)	Front internal width	57.4 in (1460 mm)
Width	73.7 in (1874 mm)	Rear internal width	56.2 in (1429 mm)
Height	57.2 in (1455 mm)	Front headroom	41.1 in (1046 mm)
Front track width	64.05 in (1627 mm)	Rear headroom	37.8 in (962 mm)
Rear track width	63.7 in (1618 mm)	Loading width	37.3 in (949 mm)
Wheelbase	114.6 in (2912 mm)	Load sill height	26.5 in (674 mm)
Curb weight	3472.2 lb (1575 kg)	Trunk capacity	18.7 cu ft / 35.1 cu ft (530 l / 995 l)
Maximum gross weight	4750.9 lb (2155 kg)	Fuel tank capacity	19.8 gal (75.0 l)
		Drag coefficient	0.26

## Overview

The body of the 2012 A6 is a hybrid, lightweight design. Aluminum components are used in addition to steel panels. The body-in-white has two aluminum cast components, the front strut mounts, as well as mild, high strength, modern high strength, and ultra high strength steel body panels.

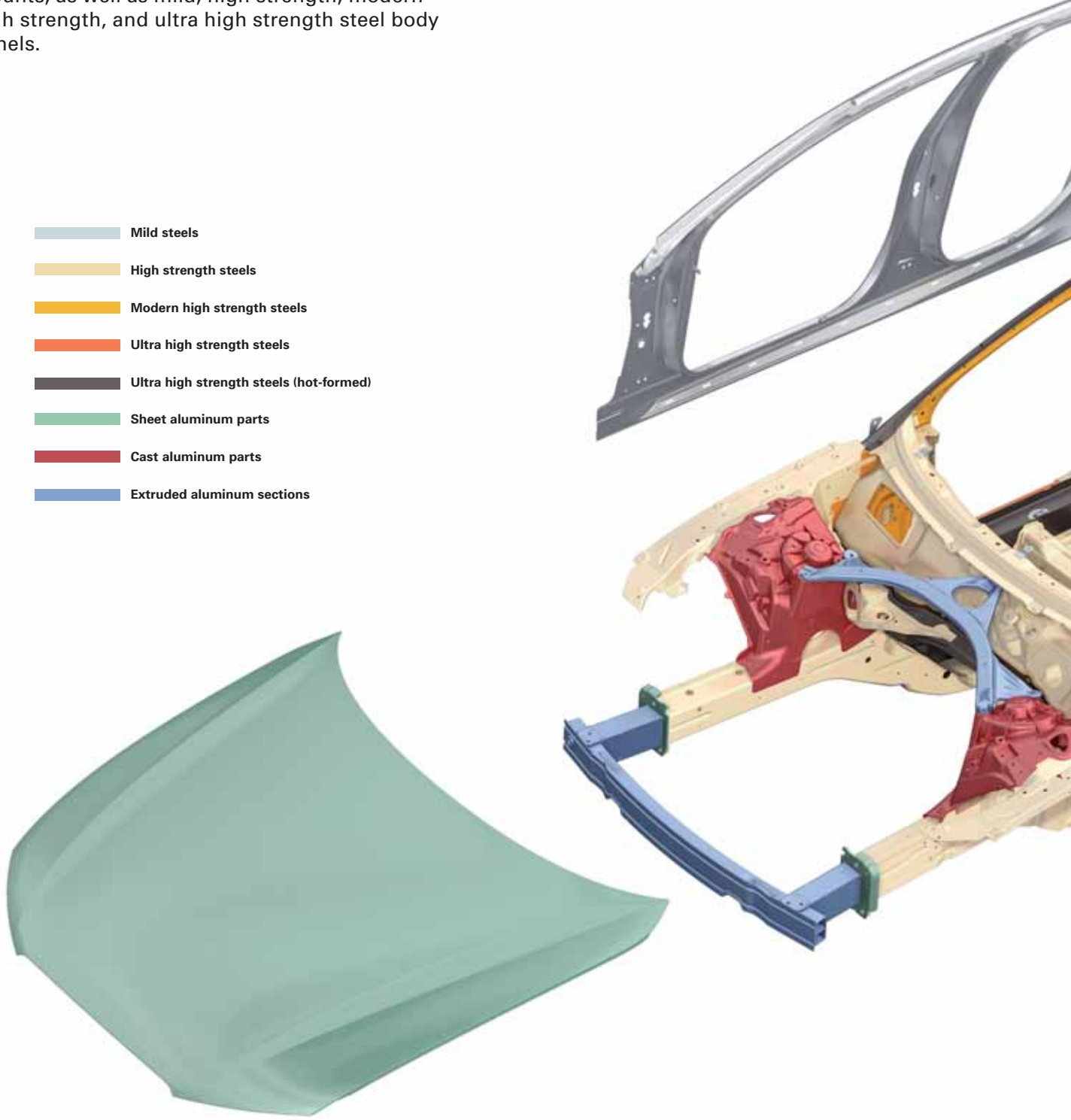



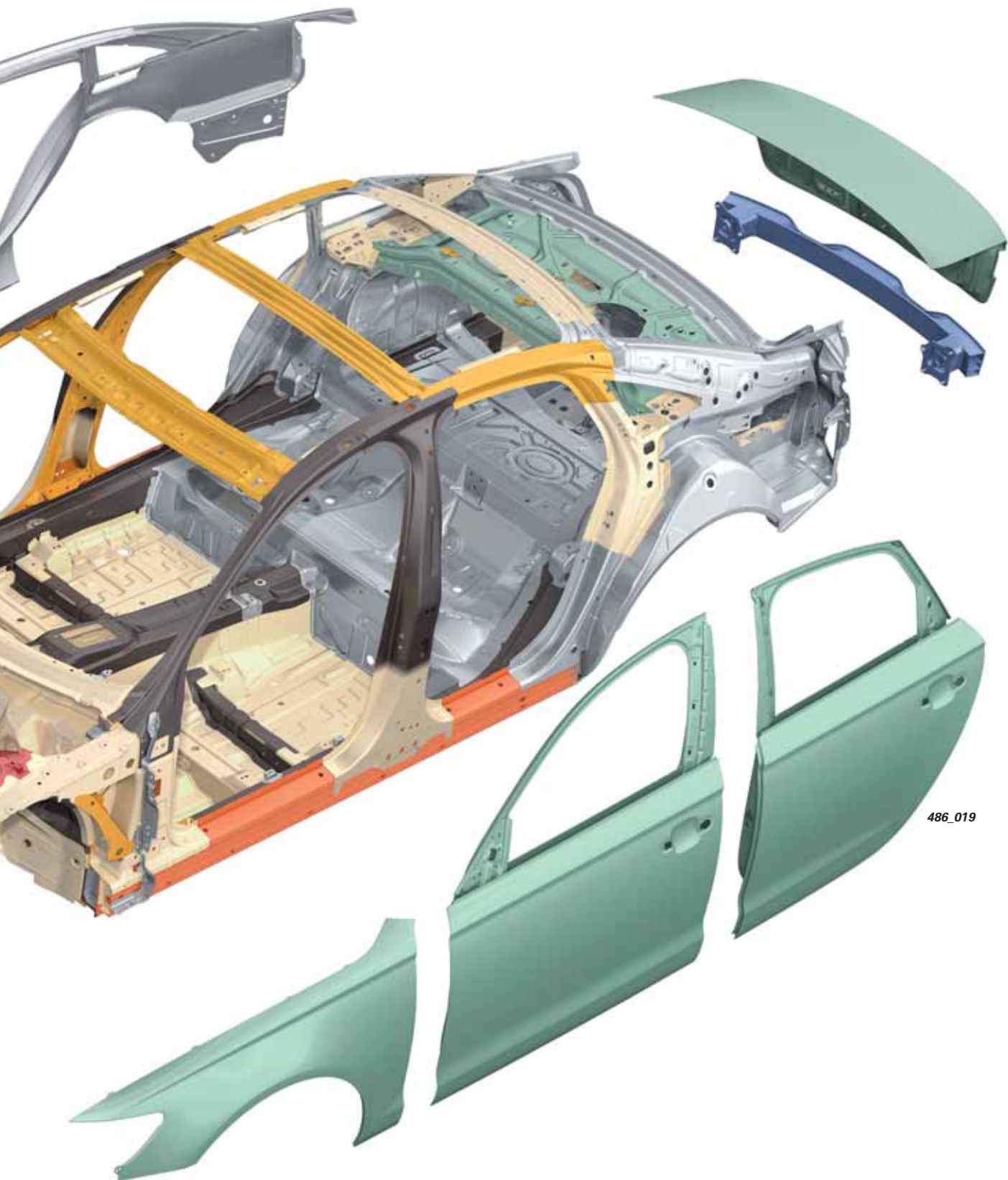

486\_019

# Occupant Protection

## Introduction

The occupant protection system in the 2012 A6 is comparable to that of the 2012 Audi A7, with individual components adapted to the A6. A safety belt warning feature for the rear passengers is new.



### Reference

For more information about the occupant safety system of the 2012 Audi A6, refer to Self-Study Program 920603, *The 2012 Audi A7 Occupant Protection, Infotainment, Climate Control, and Head-Up Display*.



486\_011

## Components

The following components are used in the 2012 A6 occupant protection system for the North American market:

- Airbag control module
- Adaptive driver and front passenger airbags
- Front side airbags
- Audi Sideguard (side curtain airbags)
- Driver and front passenger knee airbags
- Up-front airbag crash sensors
- Door-integrated pressure type sensors for side impact detection
- Acceleration-type sensors for side impact detection on the C-pillars
- Front inertia-reel safety belts with pyrotechnic and electrically reversible belt tensioners and active belt force limiters
- Battery interrupt igniter
- Safety reminder for driver and front passenger
- Safety belt switch, driver and front passenger
- Seat occupancy sensor in front passenger seat (PODS)
- Driver and front passenger seat position recognition
- Rear passenger safety belt usage warning

### Legend:

E24	Driver's Seat Belt Switch	K19	Seat Belt Indicator Light
E25	Front Passenger Seat Belt Switch	K75	Airbag Indicator Lamp
E258	Driver Side Rear Seat Belt Switch	K145	Front Passenger Airbag –Disabled– Indicator Lamp
E259	Front Passenger Side Rear Seat Belt Switch	N95	Driver Airbag Igniter
E609	Center Rear Seat Belt Switch	N131	Front Passenger Airbag Igniter 1
G128	Front Passenger Seat Occupant Sensor	N132	Front Passenger Airbag Igniter 2
G179	Driver Side Airbag Crash Sensor	N153	Driver Seat Belt Tensioner Igniter 1
G180	Front Passenger Side Airbag Crash Sensor	N154	Front Passenger Seat Belt Tensioner Igniter 1
G256	Driver Side Rear Side Airbag Crash Sensor	N196	Left Rear Seat Belt Tensioner Igniter
G257	Front Passenger Side Rear Side Airbag Crash Sensor	N197	Right Rear Seat Belt Tensioner Igniter
G283	Driver Front Airbag Crash Sensor	N199	Driver Thorax Airbag Igniter
G284	Front Passenger Front Airbag Crash Sensor	N200	Front Passenger Thorax Airbag Igniter
G551	Driver Belt Force Limiter	N201	Left Rear Thorax Airbag Igniter
G552	Front Passenger Belt Force Limiter	N202	Right Rear Thorax Airbag Igniter
G553	Driver Seat Position Sensor	N251	Driver Head Curtain Airbag Igniter
G554	Front Passenger Seat Position Sensor	N252	Passenger Head Curtain Airbag Igniter
J234	Airbag Control Module	N253	Battery Interrupt Igniter
J285	Instrument Cluster Control Module	N295	Driver Knee Airbag Igniter
J533	Data Bus On Board Diagnostic Interface	N296	Front Passenger Knee Airbag Igniter
J623	Engine Control Module	N490	Driver Airbag Release Valve Igniter
J706	Passenger Occupant Detection System Control Module	T16	Data Link Connector
J854	Left Front Seat Belt Tensioner Control Module		
J855	Right Front Seat Belt Tensioner Control Module		

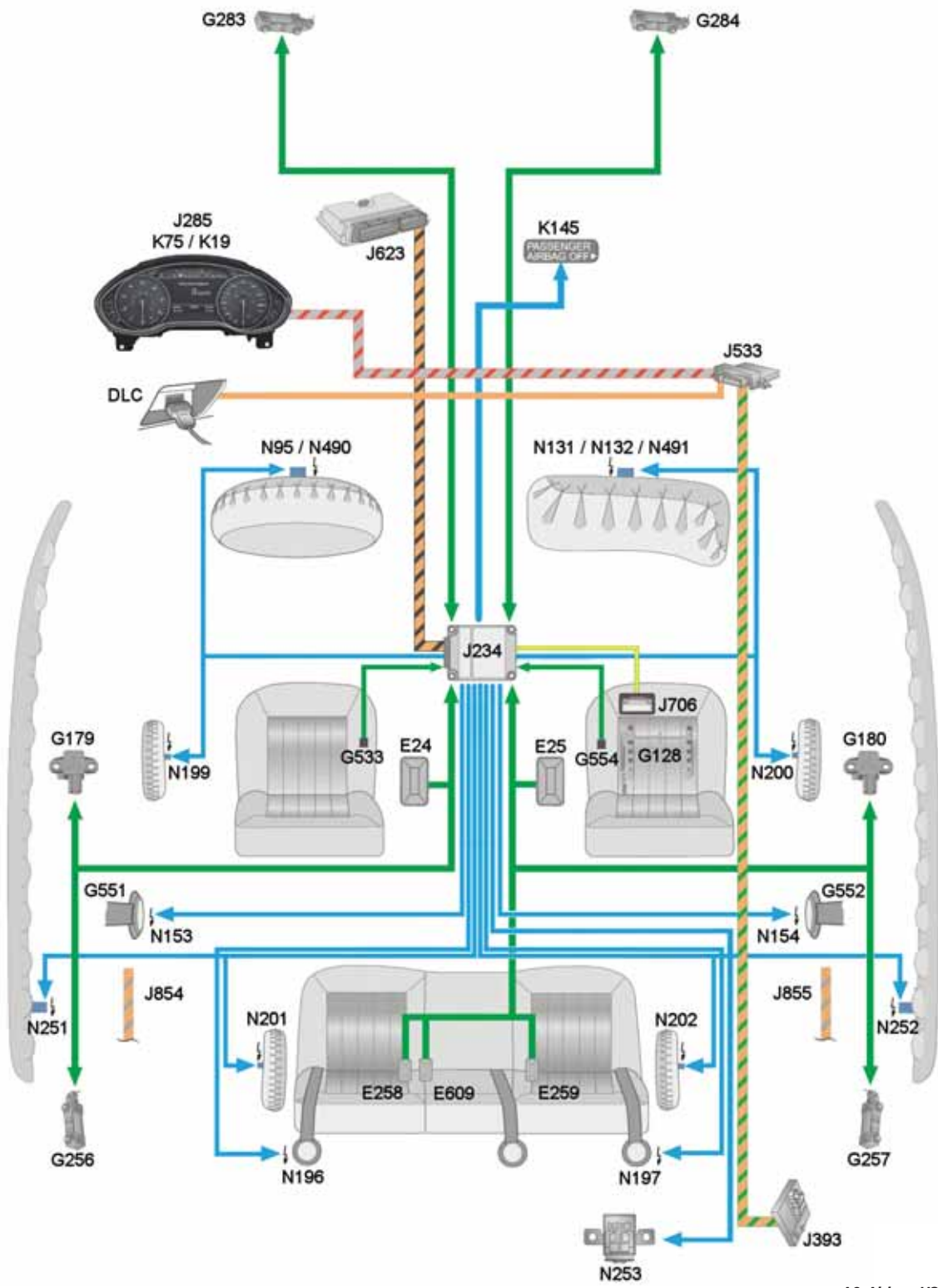

A6\_Airbag\_USAa

## Driver and Front Passenger Seat Belt Switches E24 and E25

E24 and E25 are integrated into the front safety belt buckles. These reed switches are components of the safety belt reminder system.

If the safety belt is not buckled, the reed switch is closed. In this position, a magnet built into the tip of a plastic pin acts on the reed switch.

If the safety belt is buckled, the reed switch is open. The inserted belt tongue lifts the plastic pin. The magnet no longer acts on the reed switch and it opens. Airbag Control Module J234 reads the resistance and determines if the safety belt is buckled or not.

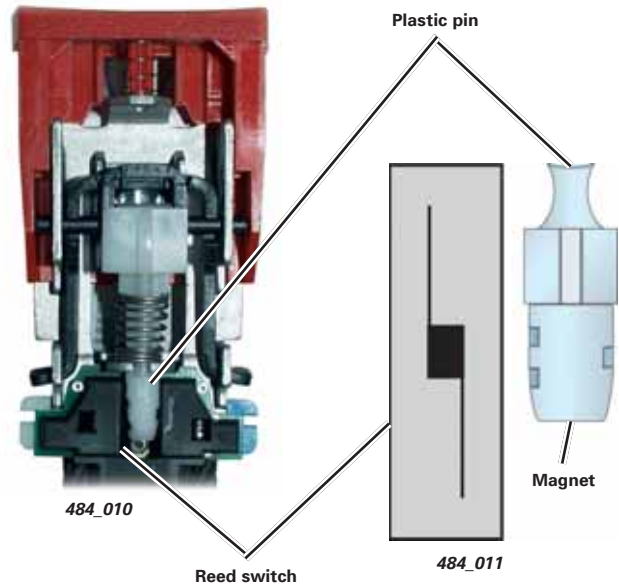

## Rear Safety Belt Reminder

After the ignition is switched ON, a status display for the rear safety belts (fastened/not fastened) appears for approximately 31 seconds in the Driver Information System of the instrument cluster.

At each change in status, a new display appears for approximately 31 seconds. If a rear-seat passenger unfastens the safety belt while the vehicle is moving at a speed above 15.5 mph (25 km/h), an acoustic warning sounds once and the corresponding indicator in the display begins flashing for approximately 31 seconds.

Airbag Control Module J234 receives the information whether the safety belts are fastened through the rear safety belt switches (E258, E259, E609.)

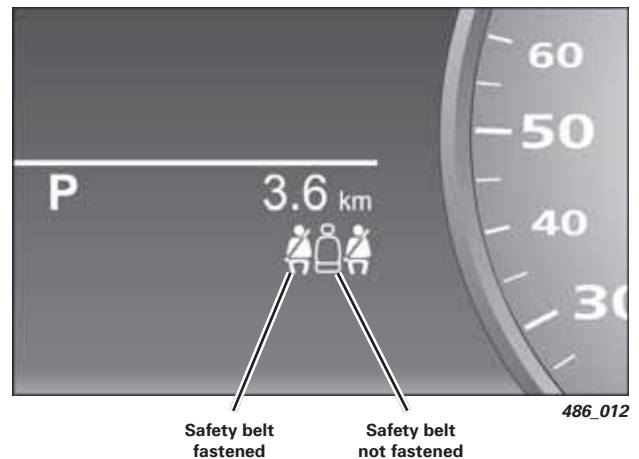

### Rear safety belt not fastened warning

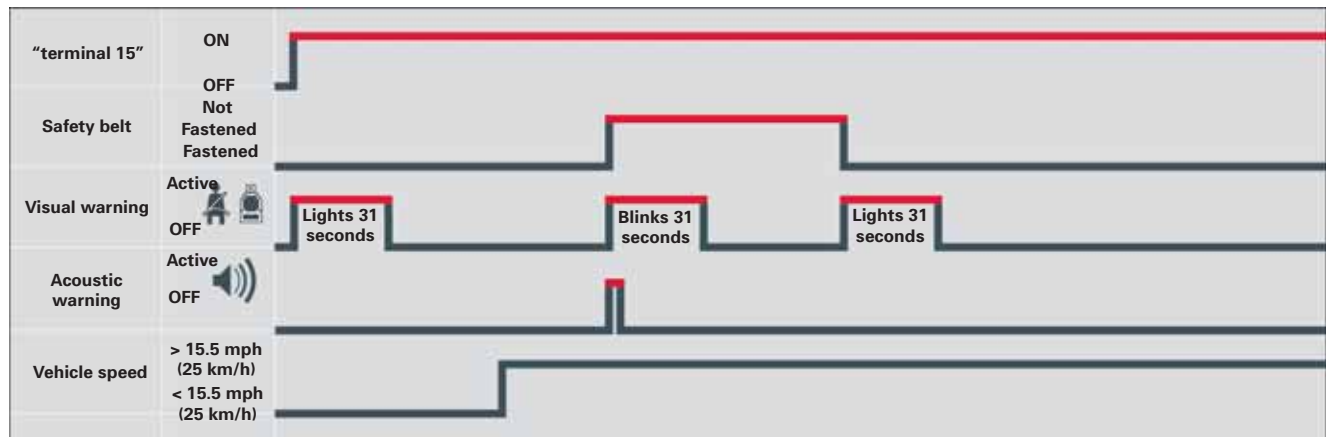

486\_013

## 3.0L V6 TFSI Engine

### Technical Features

Adapted belt drive  
(without power steering pump)



#### Modifications to the 3.0L V6 TFSI Engine for the 2012 A6

Cylinder block	– New Innovative Thermal Management System (ITM)
Cylinders	– Honed to a textured finish to reduce oil consumption and wear – Increased piston installation clearance – Reduced pre-stress on the third piston ring land
Main bearing inserts	– Bearing surfaces coated with an additional wear-resistant layer designed to withstand composite friction
Chain drive	– Chain tensioners reconfigured and adapted for reduced oil flow
Camshafts	– Weight of intake valve camshafts reduced – Cam contour revised – Weight of exhaust valve camshafts reduced – All camshafts are now composite construction
Camshaft adjusters	– Enhancements reduce leakage, resulting in reduced oil circuit pressure
Valve gear	– Reduced spring forces
Oil pump	– Smaller, consumes less power, and generates less friction
Spark plugs	– Heat ratings adapted for optimized combustion



#### Reference

For further information about the design and operation of the 3.0L V6 TFSI engine, refer to Self-Study Program 925803, *The Audi 3.0L V6 TFSI Engine with Roots Blower*.

## Specifications

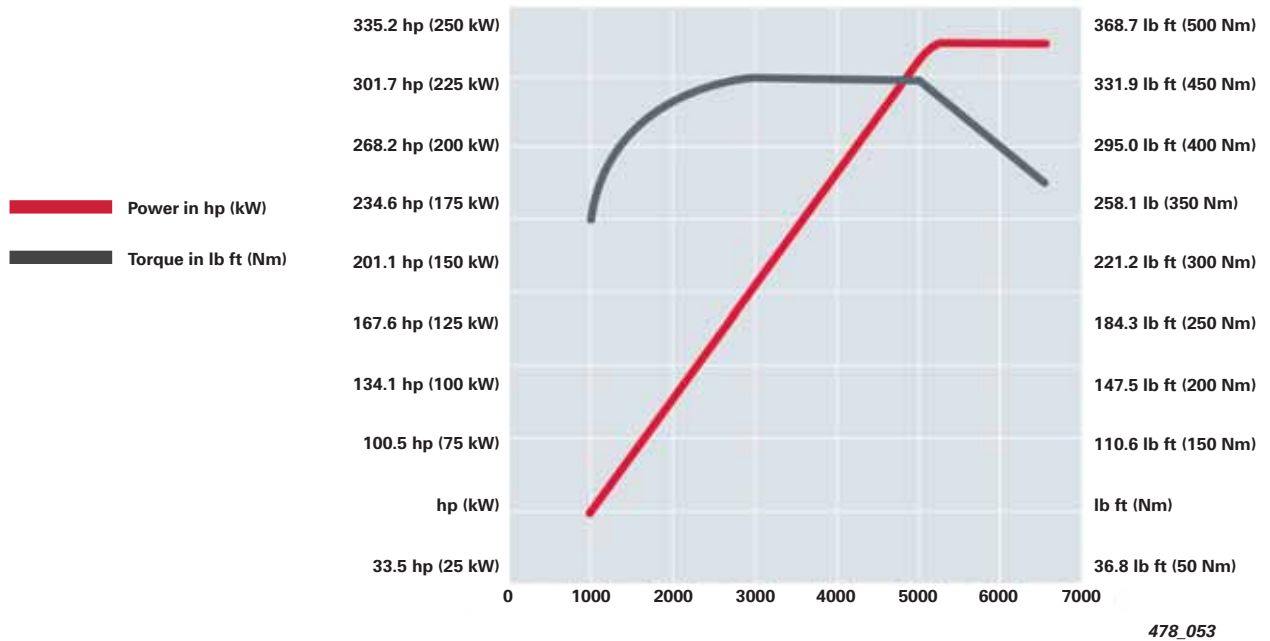

Engine Code	CGWB
Engine type	Six cylinder V engine with 90° included angle
Displacement	182.7 cu in (2995 cc)
Maximum power	310 hp (220 kW) @ 5500–6500 rpm
Maximum torque	325 lb ft (440 Nm) @ 2900–4500 rpm
Valves per cylinder	4
Bore	3.32 in (84.5 mm)
Stroke	3.50 in (89.0 mm)
Compression ratio	10.5 : 1
Powertrain	quattro
Engine management	Simos 8
Fuel grade	91 AKI
Exhaust emission standard	ULEV 2



## Innovative Thermal Management

Innovative Thermal Management (ITM) for the 3.0L V6 TFSI engine is similar to the system designed for the 2011 Audi A8 4.2L V8 TFSI. It is an electronically controlled system designed to optimally distribute engine heat flow. The system is controlled by the Heat Manager, a recently developed software module fully integrated into the engine control module (ECM).

The engine coolant is distributed on demand between the engine, transmission, and passenger compartment by a system of valves. To ensure maximum comfort, the demands of the heating and climate control systems are evaluated at all times.

The climate control and transmission control modules communicate their heating requirements to the ECM via CAN bus. These heating requirements, together with the engine heating request from the ECM, are then analyzed and prioritized. ITM components are activated accordingly.

During phase one of operation, the engine coolant does not circulate. This results in the stationary coolant temperature increasing faster than if it was circulated, thus reducing frictional losses in the engine.

After the non-circulation phase, engine coolant is used to rapidly heat the ATF via a heat exchanger. The coolant is directed by an electrical control valve actuated by the Transmission Control Module.

A mixing phase is cycled by the ECM to ensure that hot engine coolant is not circulated immediately, which would impair the frictional properties of the engine.

## Passenger Compartment Heating

The stationary coolant phase normally takes approximately 120 seconds. However, there are circumstances where stationary coolant is unwanted, for example, when the Defrost button is pressed. Warm coolant flows immediately to the heater in order to prevent the windshield from fogging up.

If the heater does not need any energy to heat the vehicle interior (at warm ambient temperatures), the climate control module does not send a heating request.

## Transmission Heating/Cooling

The ATF is heated and cooled as needed, and is only cooled to the temperature level of the engine coolant.

### ITM System Technical Summary

- Active coolant pump

Two sensors:

- Engine Temperature Control Temperature Sensor G694
- Coolant Temperature Sensor G62

- ATF heating/cooling

- Heating cut off

- Thermostat opens at 188.6°F (87°C)



### Reference

For more information about the Innovative Thermal Management system of the 3.0L V6 TFSI engine, refer to Self-Study Program 990203, *The 2012 Audi A7 Introduction*.

# ATF Heating / Cooling

## Overview

The software for the Innovative Thermal Management (ITM) system is located in the Engine Control Module. It receives information about ATF temperature from Transmission Control Module J217.

ITM controls heating and cooling of the ATF. The ECM gives the TCM the command to open or close the Transmission Fluid Cooling Valve N509.

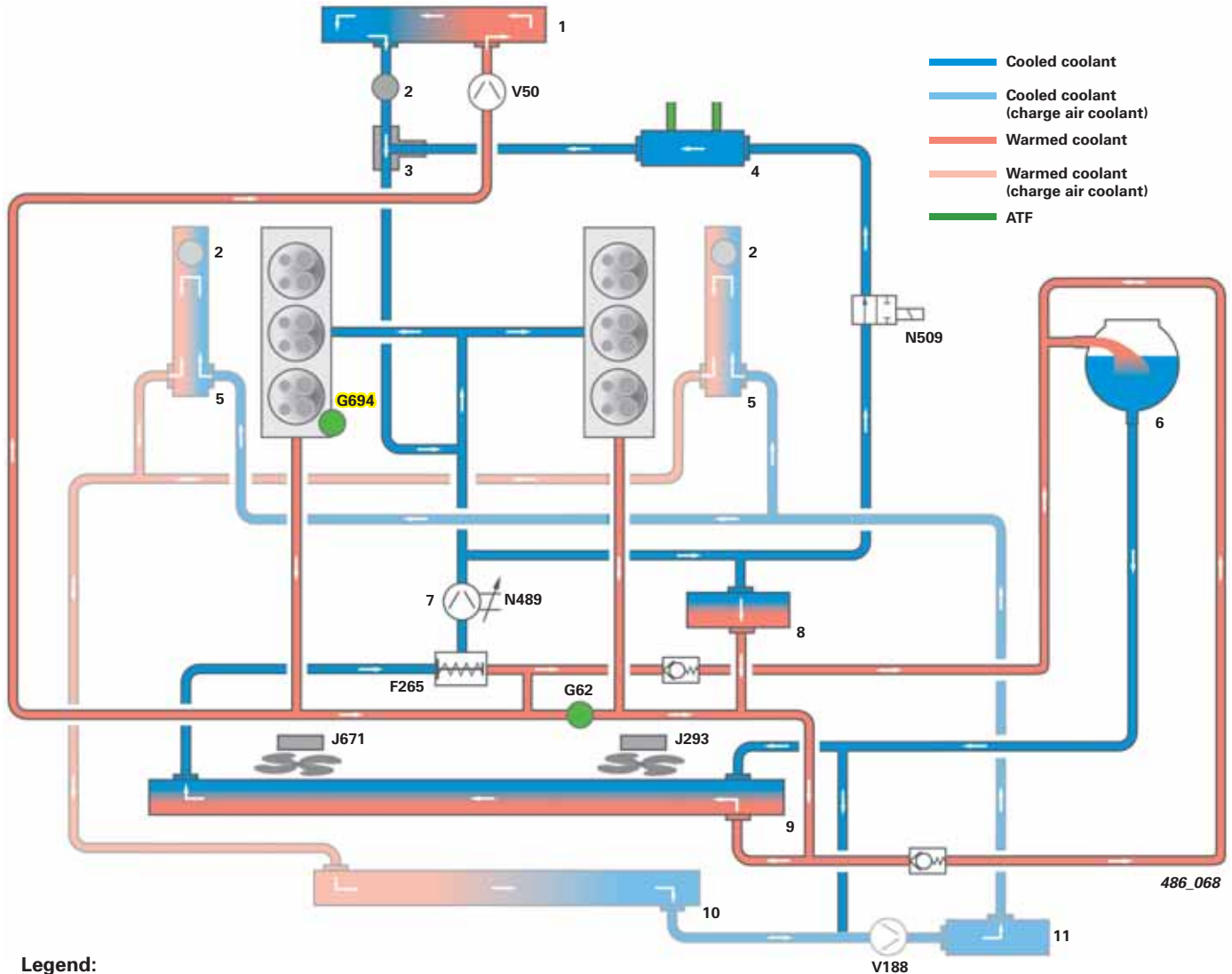

### Legend:

- |      |   |    |   |
|------|---|----|---|
| G62  | Engine Coolant Temperature Sensor             | 1  | Heat exchange (passenger compartment)               |
| G694 | Engine Temperature Control Temperature Sensor | 2  | Bleeders  |
| J293 | Coolant Fan Control Module <sup>1</sup>       | 3  | Quick connector (black)                             |
| J671 | Coolant Fan Control Module 2 <sup>1</sup>     | 4  | ATF heat exchanger                                  |
| N489 | Cylinder Head Coolant Valve <sup>1,4</sup>    | 5  | Charge air intercooler                              |
| N509 | Transmission Fluid Coolant Valve <sup>2</sup> | 6  | Engine coolant expansion bottle                     |
| V50  | Coolant Recirculation Pump <sup>3</sup>       | 7  | Active engine coolant pump                          |
| V188 | Charge Air Cooling Pump <sup>1</sup>          | 8  | Engine oil cooler                                   |
|      |   | 9  | Radiator  |
|      |   | 10 | Low temperature cooler for coolant                  |
|      |   | 11 | Low temperature auxiliary cooler for engine coolant |

<sup>1</sup> Controlled to ECM J623

<sup>2</sup> Controlled by TCM J217

<sup>3</sup> Controlled by Climatronic Control Module J255

<sup>4</sup> Switches the engine coolant pump

## Operation

### 1. Start Phase

When the engine is started cold, ECM J623 commands Transmission Control Valve J217 to close Transmission Fluid Cooling Valve N509. Coolant circulation for the ATF heat exchanger is interrupted. Initially, the variable coolant pump is inactive. Outside temperature, engine temperature, engine speed (rpm), and the heat requirements of Climatronic are criteria for switching to active. The ITM system decides when the coolant pump is switched to active through valve N509.

### 2. Heating the ATF

When the coolant pump is switched to active, ITM compares the engine temperature measured Engine Temperature Control Temperature Sensor G694 with the ATF temperature. As soon as ATF temperature is 9°F (5°C) lower than the rising engine temperature, the ECM commands the TCM to open N509. Circulation for the ATF heat exchanger is opened. The ATF is heated.

### 3. Normal Operation

When the TCM reports an ATF temperature of approximately 183.2°F (84°C) to the ECM, the ECM commands the TCM to close N509 again, interrupting coolant circulation for the ATF heat exchanger. The ATF has reached the desired operating temperature and is neither heated nor cooled. This continues up to an ATF temperature of about 221°F (105°C).

### 4. Cooling the ATF

If ATF temperature exceeds 221°F (105°C), the ECM commands the TCM to open N509, which opens circulation for the ATF heat exchanger. The ATF is cooled by the 185°F (85°C) engine coolant. Once ATF temperature has reached about 194°F (90°C), conditions for normal operation are met again. The ECM issues the command to the TCM to close N509 again.

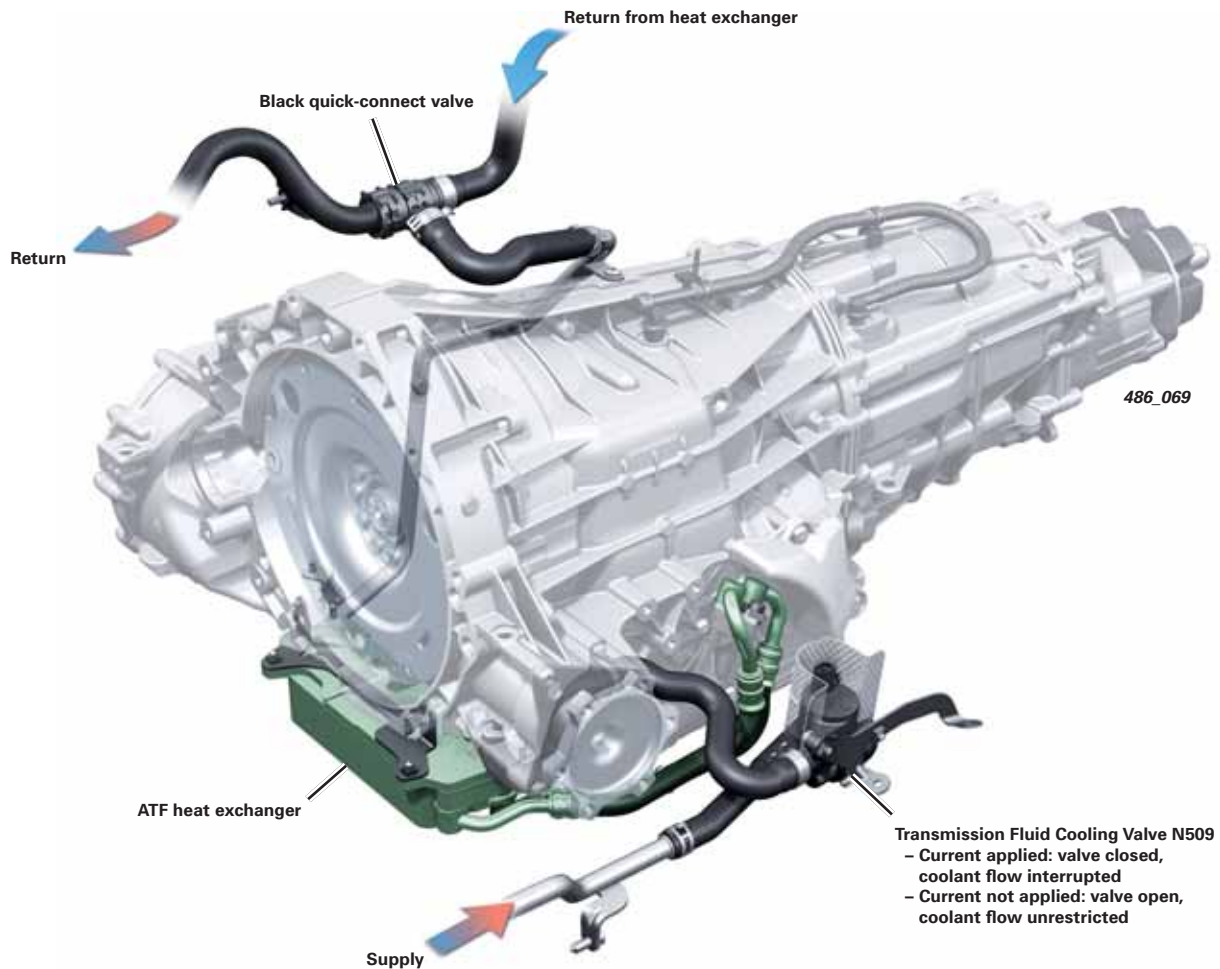

## 2.0L TFSI Engine

### Technical Features

- Exhaust gas turbocharging
- Four-valve cylinder head with a camshaft adjuster on the intake side and Audi valvelift system on the exhaust side
- Modified belt drive (no power steering pump)
- Chain-driven camshafts
- Dual path intake manifold
- Flow controlled oil pump
- Improved high pressure fuel injectors



#### Reference

For additional information about the design and construction of this engine, refer to Self-Study Program 921703, *The 2.0L Chain-Driven TFSI Engine*.

## Specifications

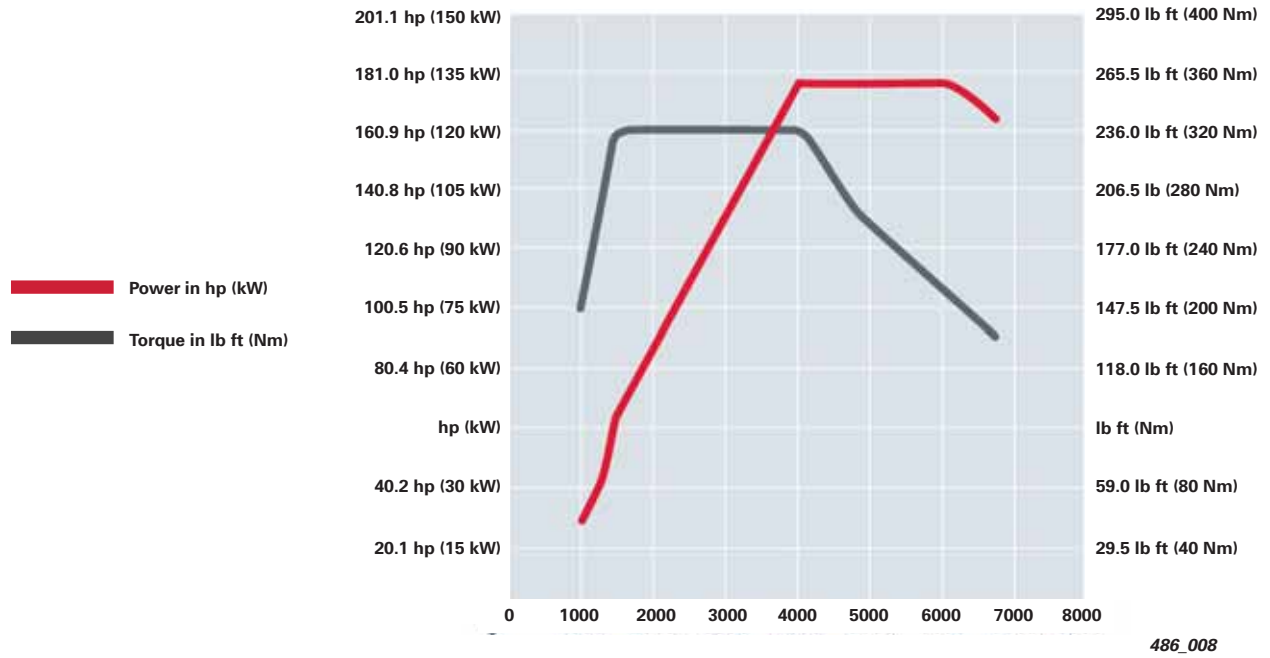

Engine Code	CDNB
Engine type	Four cylinder inline engine
Displacement	121.0 cu in (1984 cc)
Maximum power	177 hp (123 kW) @ 4000–6000 rpm
Maximum torque	236 lb ft (320 Nm) @ 1500–3900 rpm
Valves per cylinder	4
Bore	3.24 in (82.5 mm)
Stroke	3.65 in (92.8 mm)
Compression ratio	9.6 : 1
Powertrain	Multitronic
Engine management	Bosch MED 17.1
Fuel grade	91 AKI

# ATF Cooling

## Overview

On vehicles with the 2.0-liter inline 4-cylinder engine, there is no ATF heating.

Above an engine coolant temperature of about 176°F (80°C), the cooling circuit for the ATF heat exchanger is integral with the cooling circuit for the engine through the thermostat.

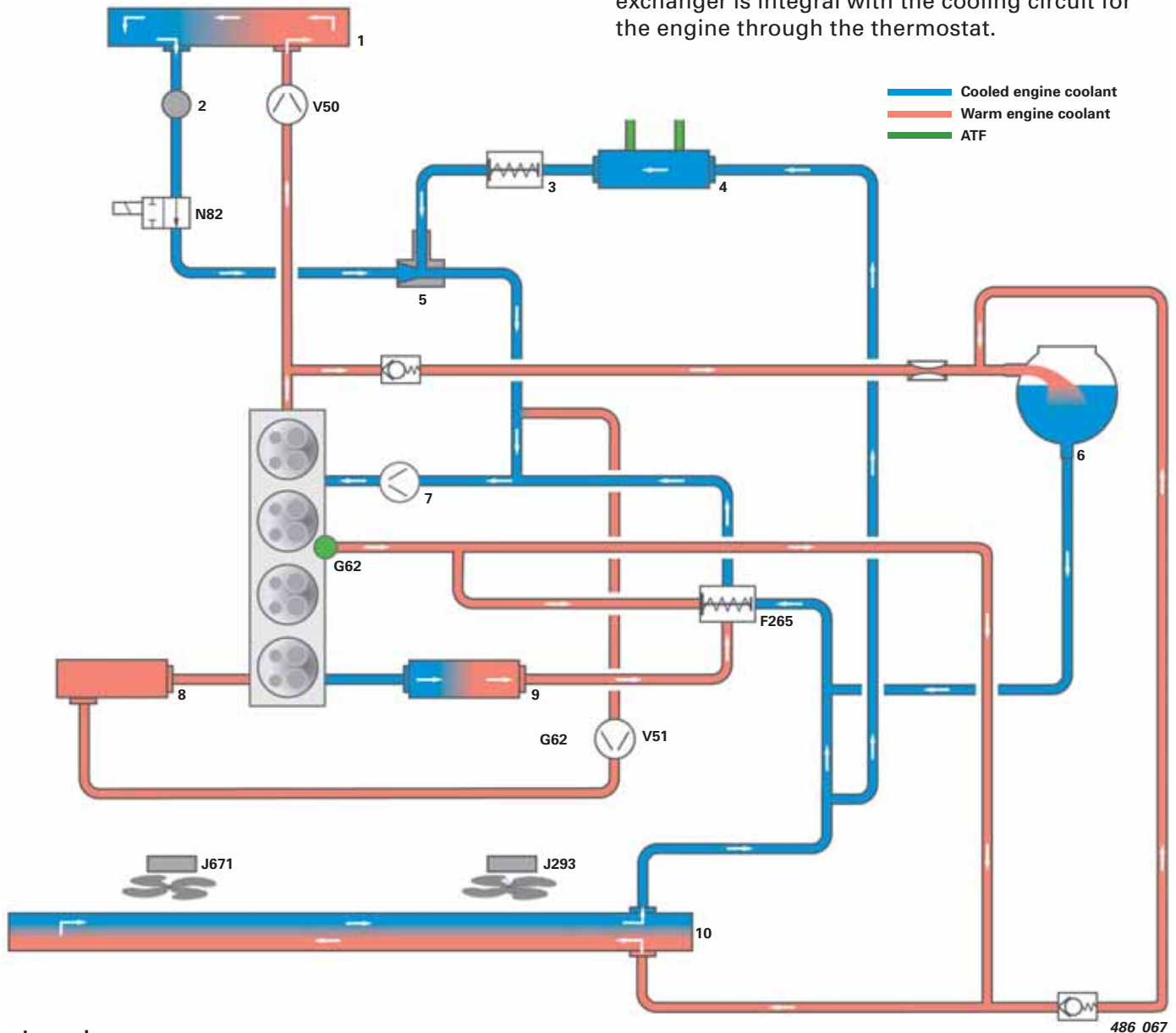

### Legend:

- G62 Engine Coolant Temperature Sensor
- F265 Map Controlled Engine Cooling Thermostat<sup>1</sup> (opening begins at approximately 203°F [95°C])
- J293 Coolant Fan Control Module<sup>1</sup>
- J671 Coolant Fan Control Module 2<sup>1</sup>
- N82 Coolant Shut-Off Valve<sup>2</sup>
- V50 Coolant Recirculation Pump<sup>2</sup>
- V51 After-Run Coolant Pump<sup>1</sup>

- 1 Heat exchange (passenger compartment)
- 2 Bleeder
- 3 ATF engine coolant regulator (opening begins at approximately 176°F [80°C])
- 4 ATF heat exchanger
- 5 Quick connector with restrictor, gray
- 6 Coolant expansion bottle
- 7 Water pump
- 8 Turbocharger
- 9 Engine oil cooler
- 10 Radiator

<sup>1</sup> Controlled to ECM J623

<sup>2</sup> Controlled by Climatronic Control Module J255

## Quick Connector with Restrictor

The quick connect with restrictor (gray) is used in vehicles with the 2.0L, 4-cylinder TFSI engine. A quick connect without restrictor (black) is used on vehicles with the 3.0L V6 TFSI engine.

If the quick connect without restrictor (black) is installed in vehicles with the 2.0L TFSI engine instead of the specified quick connect with restrictor (gray), the cooling performance of the ATF heat exchanger will be reduced. This can cause elevated ATF temperatures.

## ATF Thermostat

An ATF coolant regulator is installed in the coolant return of the ATF heat exchanger. A groove in the valve seat allows a very small permanent flow of engine coolant. If coolant temperature rises, the wax in the thermal element is heated and expands. As a result, it opens the valve seat through the lift rod and coolant circulation is enabled when the coolant temperature reaches 176°F (80°C).

## Direction of Flow

When installing the ATF coolant regulator, strict attention must be paid to the direction of flow, which is identified by an arrow on the regulator housing.

In the event of incorrect installation, regulation is undesirably affected and ATF cooling is obstructed. If the groove in the valve seat is contaminated, the very small permanent flow of coolant is interrupted, and the thermal element is not properly heated. The valve seat remains closed and the ATF is not cooled.

If there is excessive ATF temperature, then coolant and fluid circulation to the ATF heat exchanger, as well as the coolant regulator, must be checked.

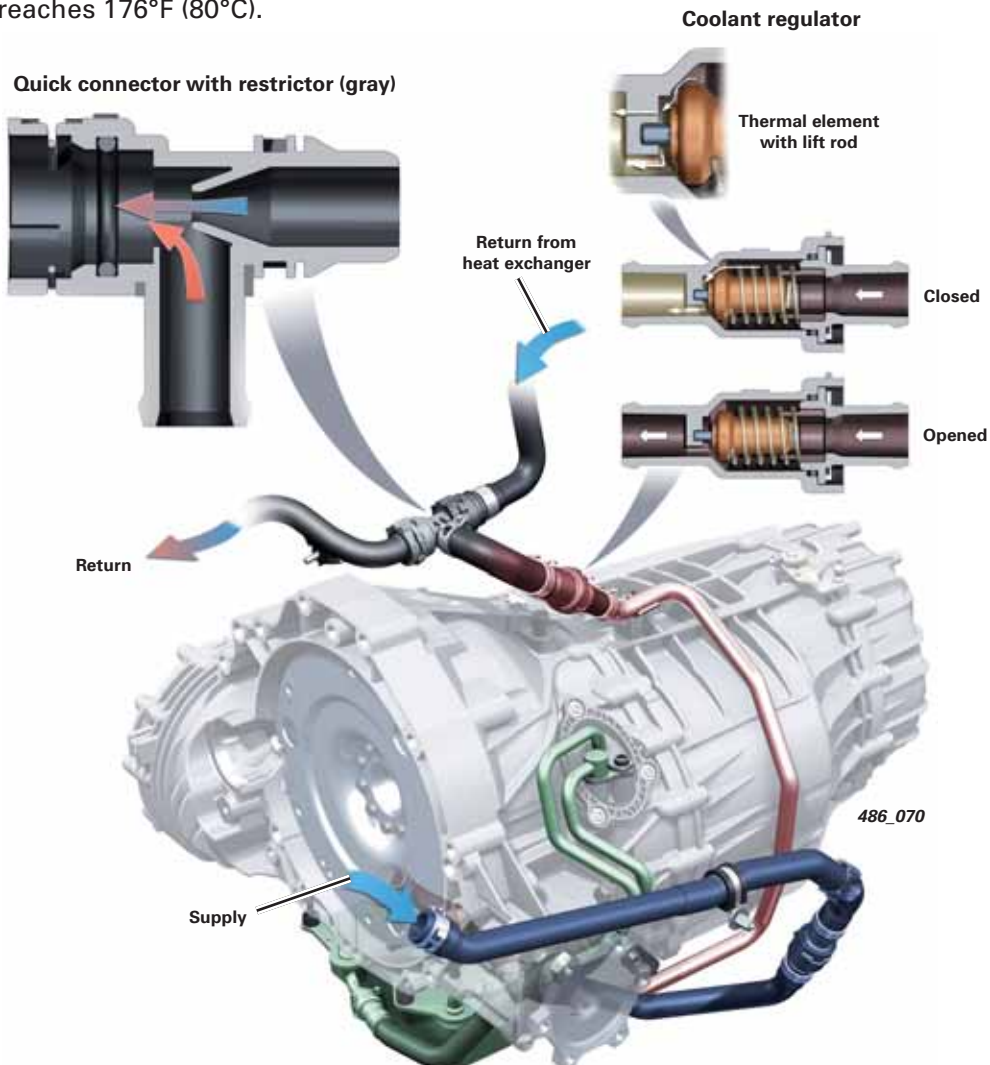

# Power Transmission

## Overview

The 2012 A6 is introduced with the 8-speed 0BK automatic transmission. This transmission was designed specifically for the North American market.

It is the same transmission used in the 2011 A8 but does not feature the “shift-by-wire” control system. Instead, it uses a cable operated mechanical selector.

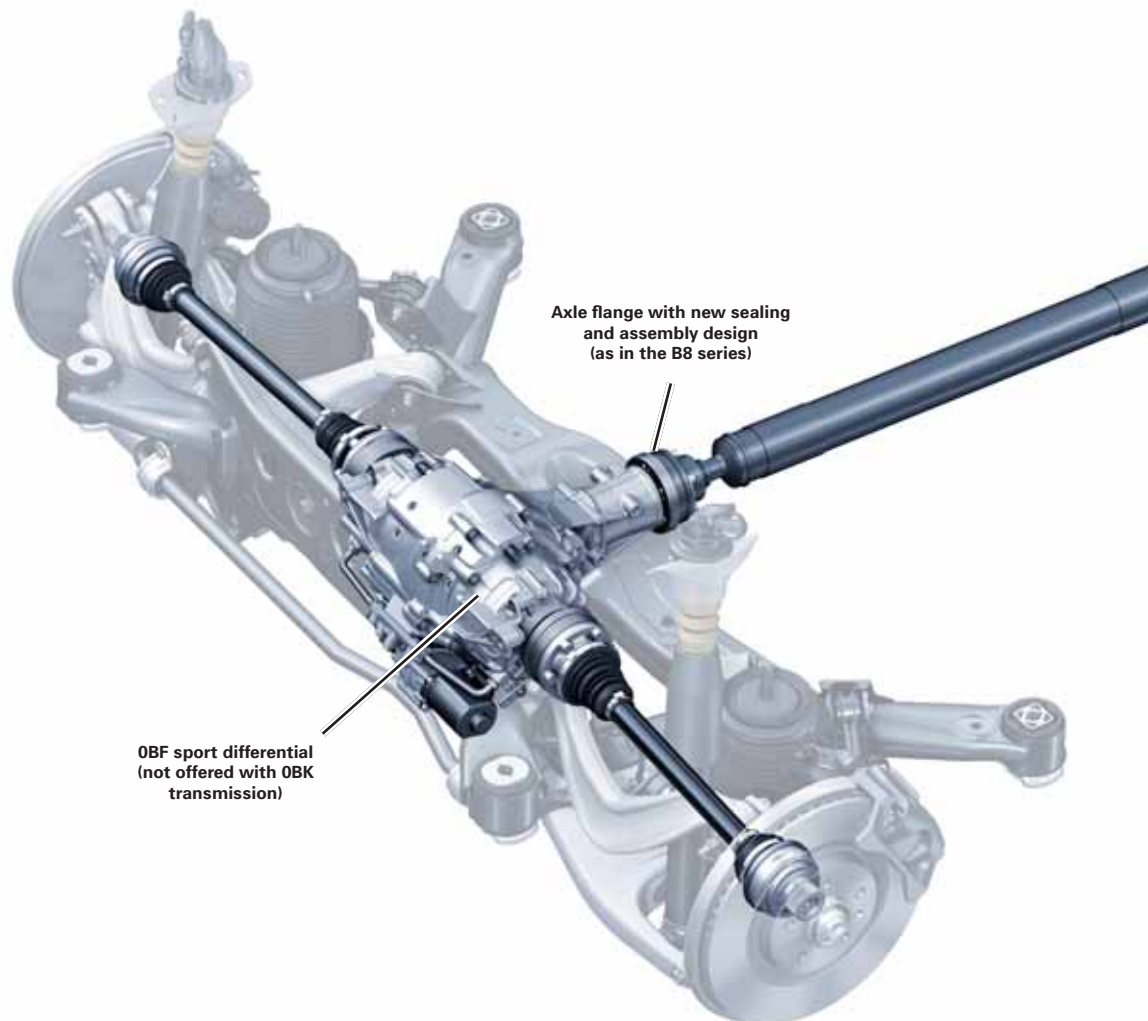

### Reference

For more details about the mechanical operation of the 0BK transmission, refer to Self-Study Program 950103, *The 2011 Audi A8 Power Transmission*.



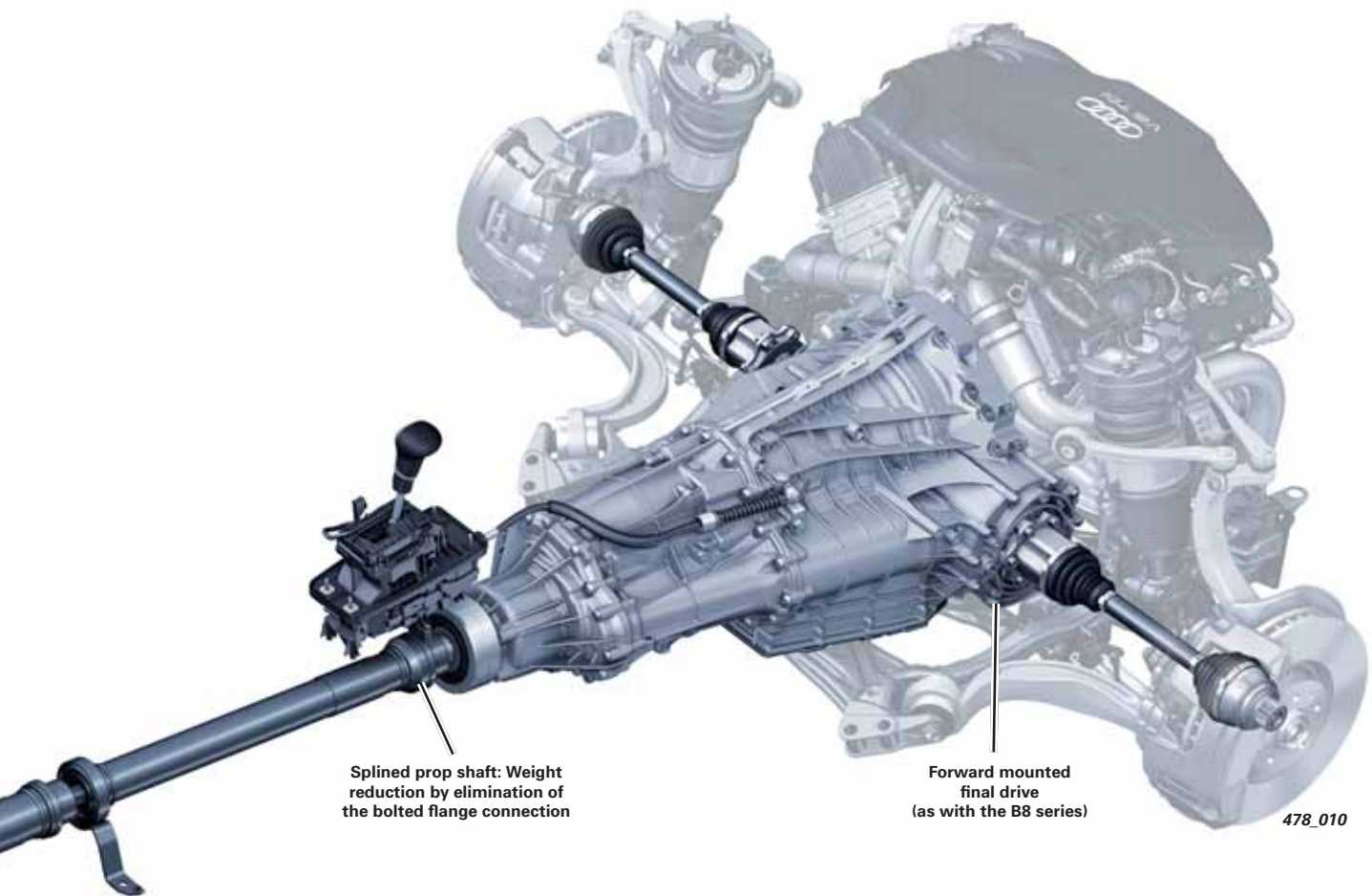

Splined prop shaft: Weight reduction by elimination of the bolted flange connection

Forward mounted final drive (as with the B8 series)

478\_010



478\_027

Multitronic 0AW

- Step-less transmission for future front-wheel drive models with engines rated up to 295 lb ft (400 Nm)



478\_011

0B5 S tronic 7-speed transmission

- 7-speed dual clutch transmission for future use on quattro models

# Suspension System

## Overview

One of the key development goals for the A6 was to provide outstanding agility, driveability and driving enjoyment while also offering a high standard of safety and comfort. This was made possible by adopting the proven design of Audi's five-link front suspension combined with a self-tracking trapezoidal-link rear axle.

A steel-sprung suspension with conventional shock absorbers is standard.

The A6 uses the same powertrain design that was first used on the Audi A5, with the axle drive positioned ahead of the differential to provide a large wheelbase and small front overhang.

Mounting the steering gear on the subframe in front of the front axle provides the necessary, exact steering response and a precise steering feel in every driving situation.

Electro-mechanical steering provides improved fuel economy in addition to allowing more functional options related to handling and control.

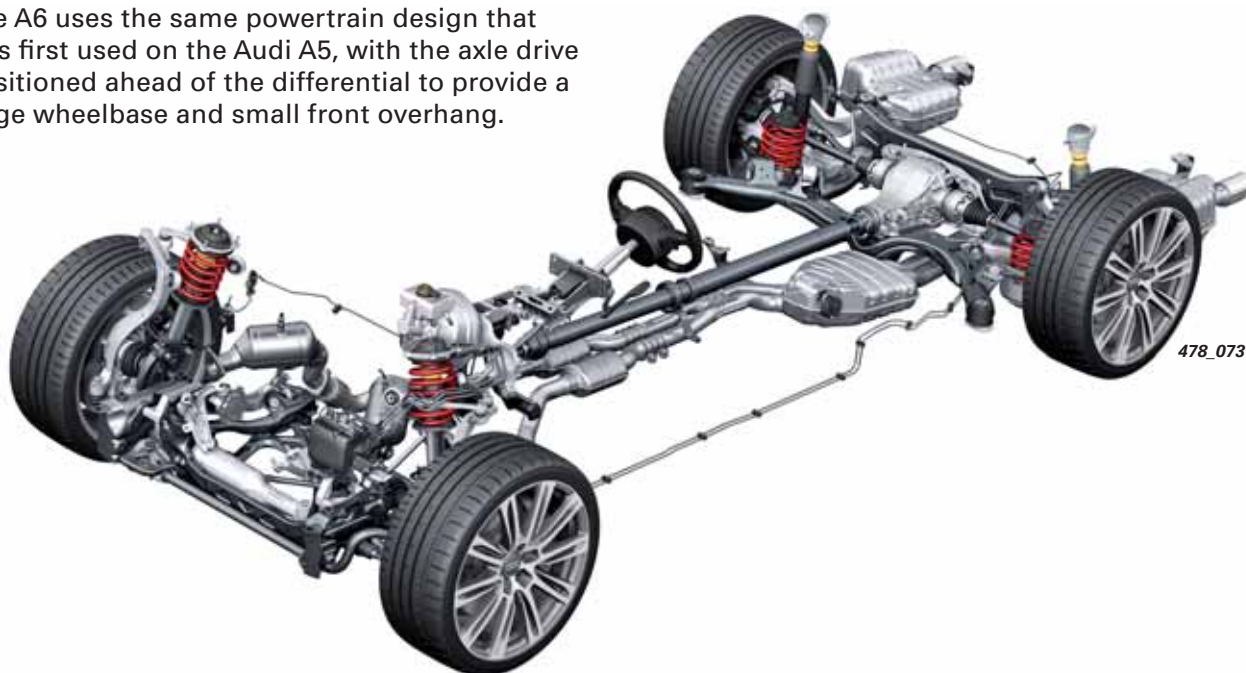

Production Control Number (PR)	Description	Technical Implementation	Offer
1BA	Standard running gear /suspension	Steel suspension	Series standard
1BE	Sports running gear /suspension	Steel suspension	Option
1BV	Sports running gear /suspension S line (offered from quattro GmbH)	Steel suspension	Option
1BK	Adaptive air suspension (not available at launch)	Air suspension	Option



### Reference

For further information about the suspension system of the 2012 A6, refer to Self-Study Program 990303, *The 2012 Audi A7 Running Gear and Suspension*.

## Axles

### Front Axle

The A6 uses the five-link front suspension of the 2011 A8 as a starting point. The bearing pedestal that supports the upper wishbone has been integrated into the body shell.

In addition to saving weight and increasing rigidity, this also reduces the fitting tolerances of the upper wishbones. Anti-roll bars and shock absorbers have been reconfigured to meet the design objectives of the A6.



### Rear Axle

The rear suspension design is based on the trapezoidal link rear axle used on the Audi Q5.

Springs and shock absorbers are separated from one another, providing a large pass-through loading width and a flat load floor.



# Electromechanical Steering

## Overview

The new generation of electromechanical power steering used on the 2012 A7 is also used on the 2012 A6. The power assist is accomplished via an electric motor arranged concentrically in relation to the steering rack. This design was selected because it enables high performance capability with relatively small space requirements.

The rack, electric motor, ball screw assembly, control module and necessary sensors are integrated into a compact unit.

This complete steering system is approximately 35.2 lb (16 kg) lighter than earlier versions. The weight reduction means better fuel consumption and increased functionality with other vehicle safety and handling systems.

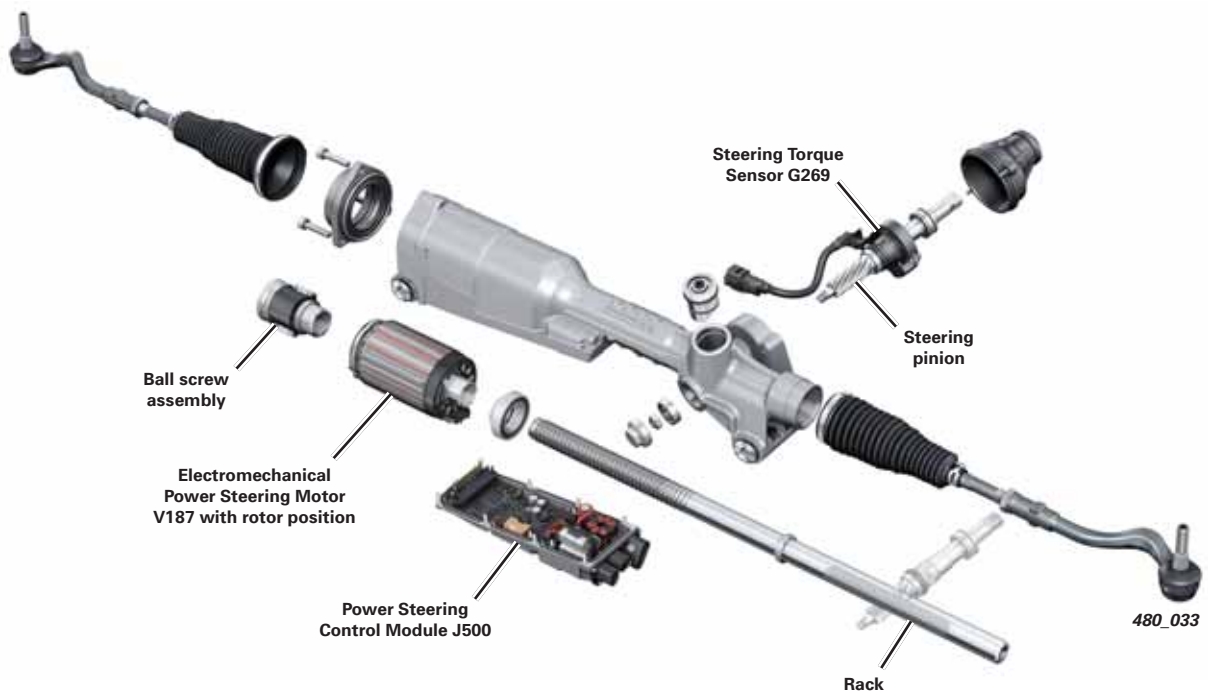

# Brake System

## Overview

The A6 brake system is similar in design and operation to that of the 2011 A8 and 2012 A7. An electromechanical parking brake is used at the rear.

A high performance ESP by Bosch, which has an extended range of functions, provides a high standard of safety. As on the 2011 A8, Sensor Electronics Control Module J849 supplies information about vehicle dynamics for calculation of desired control operations. The system used in the A6 is identical to that of the A8.

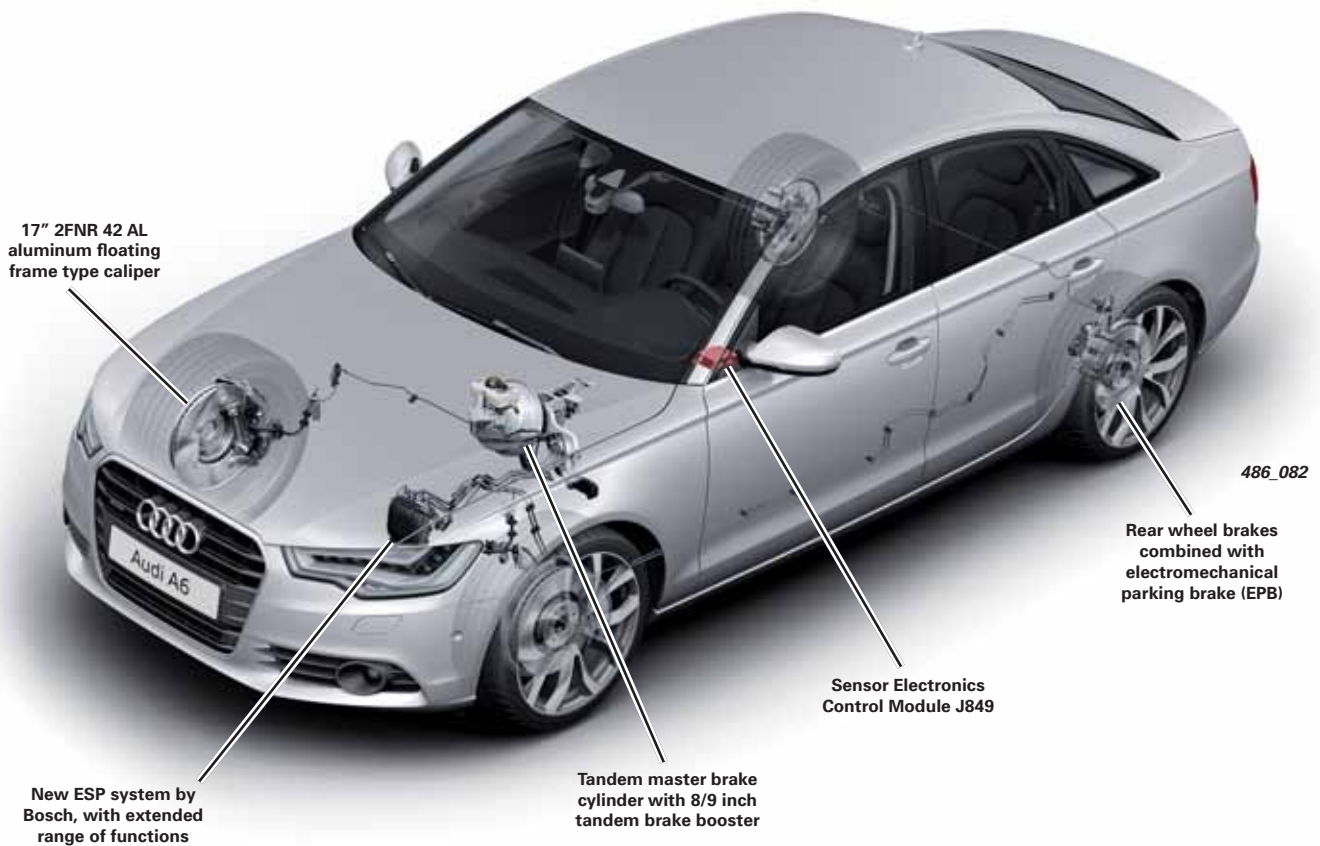

## ESP

The 2012 A6 uses the 9th generation ESP Premium. The range of functions was expanded for the future use of dynamic steering.

ABS Control Module J104 determines necessary steering intervention to assist vehicle stability. To do this, the values measured by the wheel speed sensors, the steering angle sensor, Sensor Electronics Control Module J794, and the rotor position sensor of the dynamic steering actuator are processed.

When needed, J104 then “instructs” the control unit for Active Steering Control Module J792 to perform a steering correction, irrespective of the steering action by the driver. This feature will not be available during the 2012 model year.

Diagnosis procedures are identical to those for the Audi A6. As already implemented in the Audi A6, the innovative functions of wheel-selective torque vectoring (for quattro drive) and the electronic locking differential (for front-wheel drive) are also used in the 2012 A6.

The control module can be removed from the hydraulic unit for service and replaced separately. The installation operations must be performed in an ESD-protected workplace using special service tool VAS 6613.

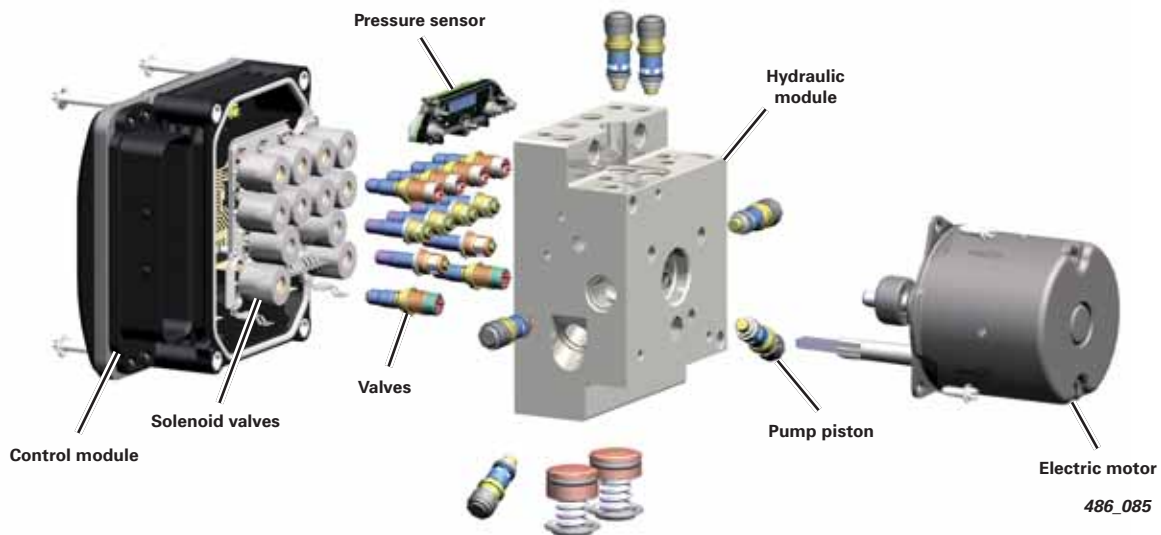

## Tire Pressure Monitoring

Audi’s familiar second-generation tire pressure monitoring system is also used on the A6. The system is standard on this model worldwide and is identical to those already in use on other Audi models.



## Audi Drive Select

Audi Drive Select will also be offered on the 2012 A6.



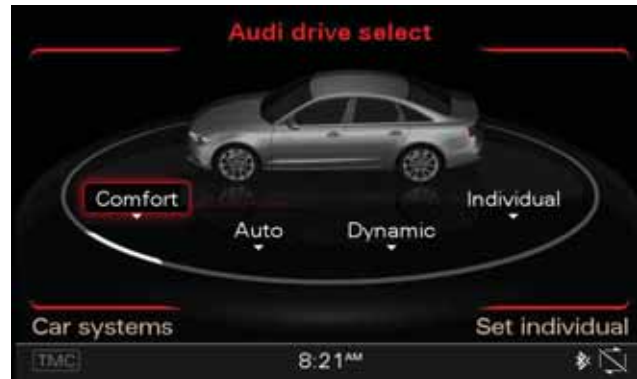

There are three modes: **comfort**, **auto**, and **dynamic**. The driver can select these via the MMI control panel and, for example, switch from a sport to a comfort driving mode. The driver can use the individual mode to configure the vehicle.

For instance, a sport engine setup can be combined with light steering action. The model and option level dictates which systems can be configured by Audi drive select. In all cases, the engine, transmission, and steering systems are controlled.



A6\_AudiDriveSelect

### Mode Characteristics

		comfort	auto	dynamic
	Engine/transmission	balanced	balanced	sport
	Air suspension*	comfort	balanced	sport
	Steering	comfort	balanced	sport
	Sport differential*	balanced	responsive	sport
	Reversible belt pretensioners	standard	standard	adapted activation timing

\*Not on US models at the introduction of the A6.



#### Reference

For more information about the Audi drive select system and its mode characteristics, refer to Self-Study Program 990203, *The 2012 Audi A7 Vehicle Introduction*.

# Electrical System

## Power Supply Overview

Refer to current technical literature for exact fuse assignments and cable routing.

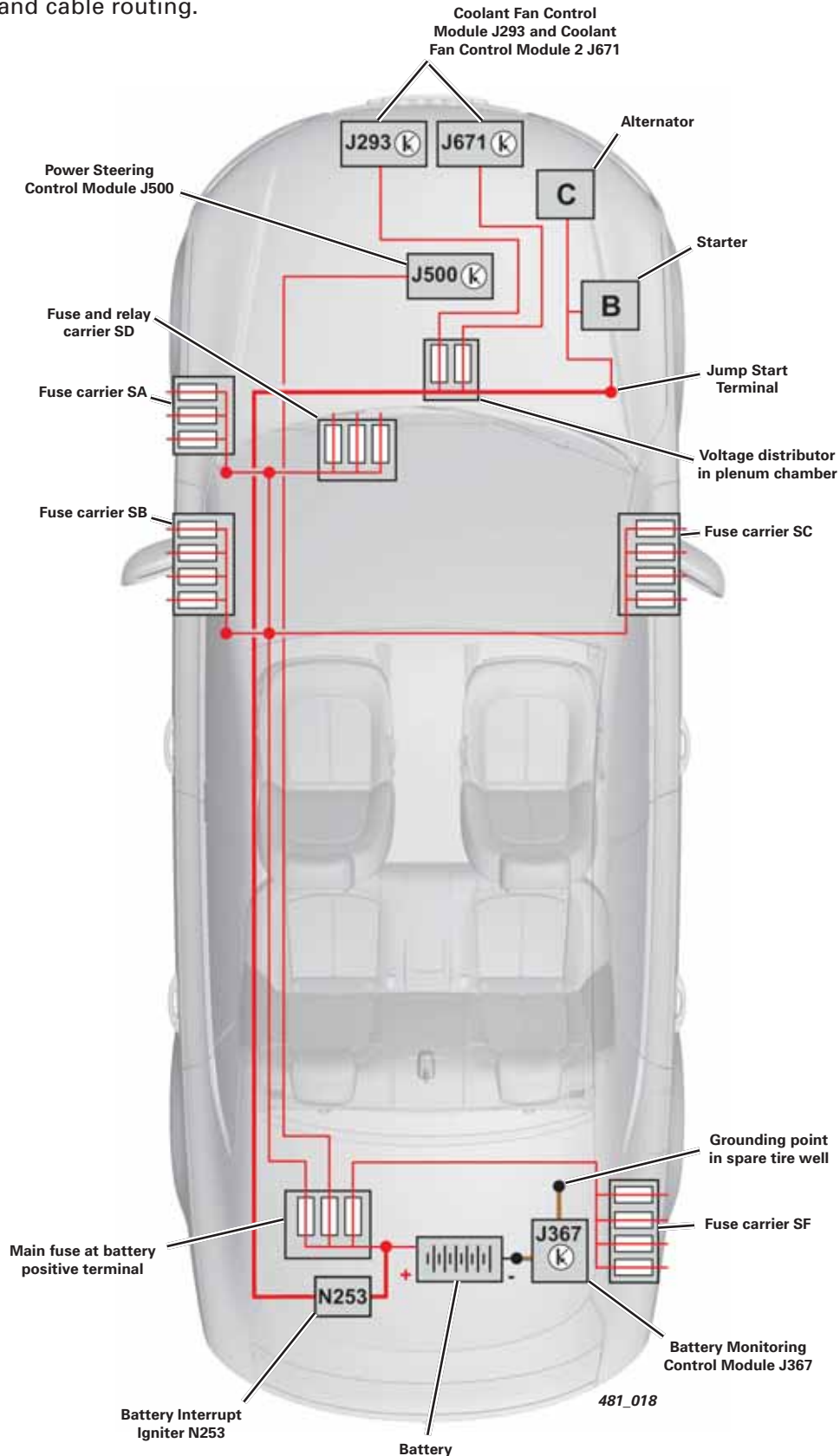



## Fuses and Relays

### Voltage distributor in plenum chamber

The coolant fan control modules are supplied power via fuses located at this point. The main battery cable junction point is here.

### Fuse and relay carrier on the right side of the instrument panel

The fuses are labeled SC in the current flow diagram. They can be accessed by the customer after removing the instrument panel end cover.

### Fuse and relay carrier and CAN node connector in luggage compartment, right

The fuses are labeled SF in the current flow diagram. The fuses can be accessed by the customer after removing the storage compartment on the right side.

### Main fuse carrier at battery positive terminal

The battery interrupt igniter is also mounted on this fuse carrier.

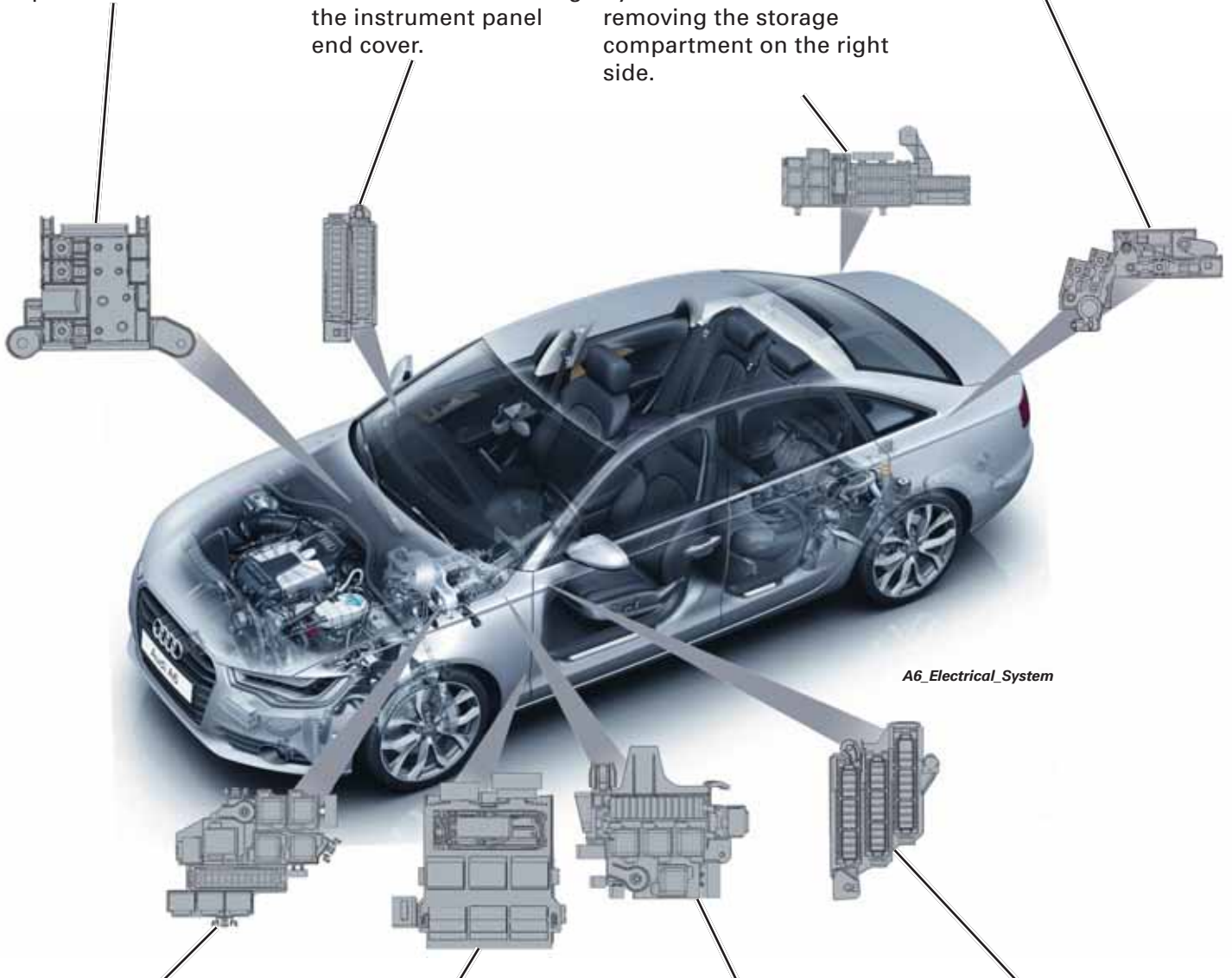

A6\_Electrical\_System

### Fuse and relay carrier in the E-box in the plenum chamber, driver side

(under the windshield washer system reservoir)  
The E-box lid also serves as a support for the engine control module. The fuses in the E-box are labelled SA in the current flow diagram.

### Coupling station and CAN node connector at the bottom left A-pillar

### Fuse and relay carrier in the Vehicle Electrical System Control Module area

(below the instrument panel in the driver footwell)  
The fuses are labeled SD in the current flow diagram.

### Fuse and relay carrier on the instrument panel, left

The fuses are labeled SB in the current flow diagram. They can be accessed by the customer after removing the instrument panel end cover.

## Control Module Locations

Some of the control modules shown in this overview are optional and/or are country-specific equipment. Boxes without numbers in the illustration indicate locations for components not used in the North American market. The color of a box indicates which data bus it communicates on.

Refer to current technical literature for exact installation locations of control modules, as well as for installation and removal instructions.

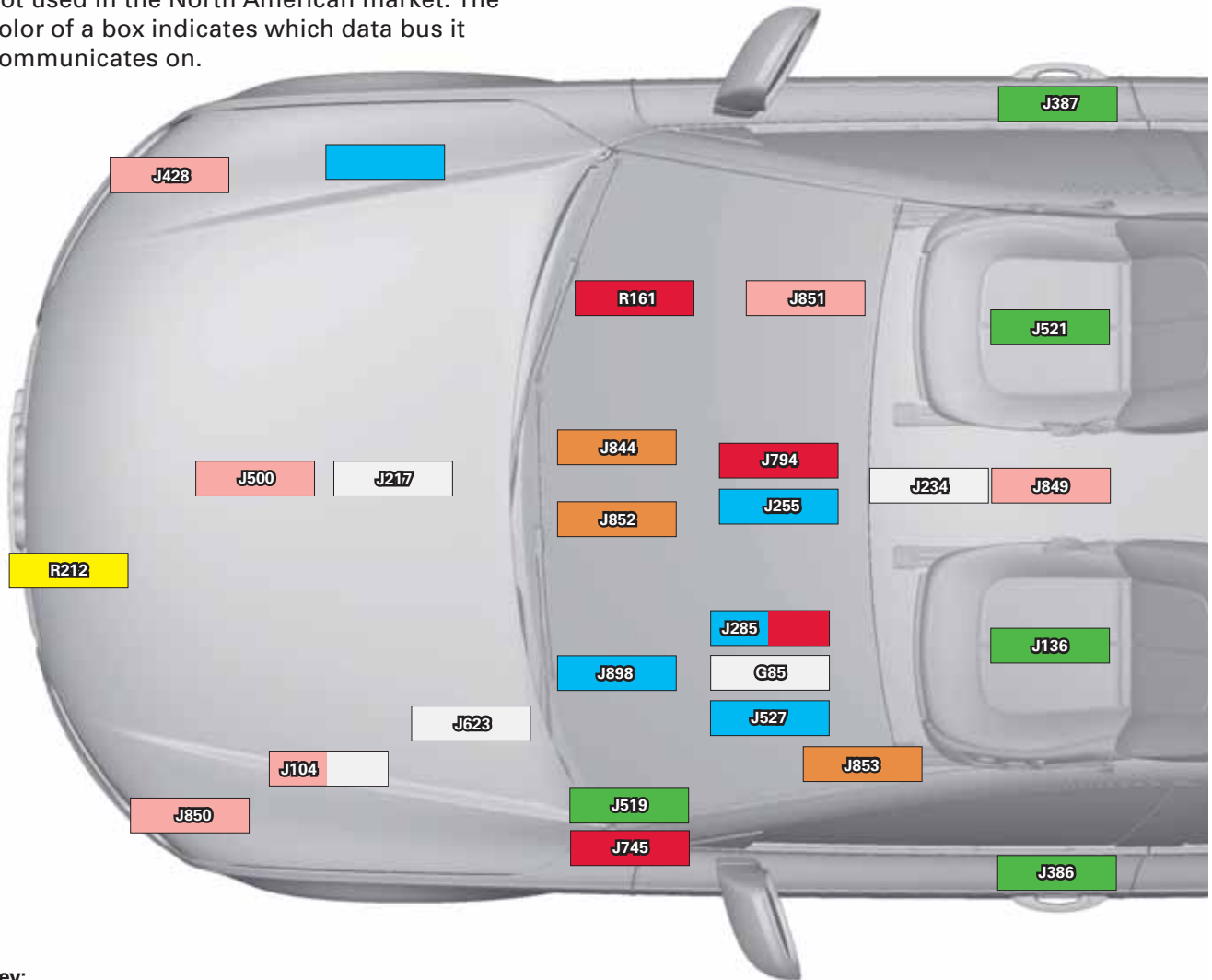

### Key:

<span style="display: inline-block; width: 15px; height: 15px; background-color: green; border: 1px solid black;"></span>	<b>Control Modules on the Convenience CAN bus</b>
J136	Memory Seat/Steering Column Adjustment CM
J386	Driver Door Control Module
J387	Front Passenger Door Control Module
J393	Comfort System Central Control Module
J519	Vehicle Electrical System Control Module
J521	Front Passenger Memory Seat Control Module
J605	Rear Lid Control Module
J872	Front Passenger Multicontour Seat CM
J873	Driver Multicontour Seat Control Module

<span style="display: inline-block; width: 15px; height: 15px; background-color: blue; border: 1px solid black;"></span>	<b>Control Modules on the Display and Control CAN bus</b>
E265	Rear A/C Display Control Head
J255	Climatronic Control Module
J285	Instrument Cluster Control Module
J527	Steering Column Electronics Control Module
J772	Rear View Camera System Control Module
J791	Parallel Parking Assistance Control Module
J898	Windshield Projection Head-Up Display CM

<span style="display: inline-block; width: 15px; height: 15px; background-color: white; border: 1px solid black;"></span>	<b>Control Modules on the Powertrain CAN bus</b>
G85	Steering Angle Sensor
J234	Airbag Control Module
J540	Electromechanical Parking Brake Control Module
J623	Engine Control Module
J217	Transmission Control Module

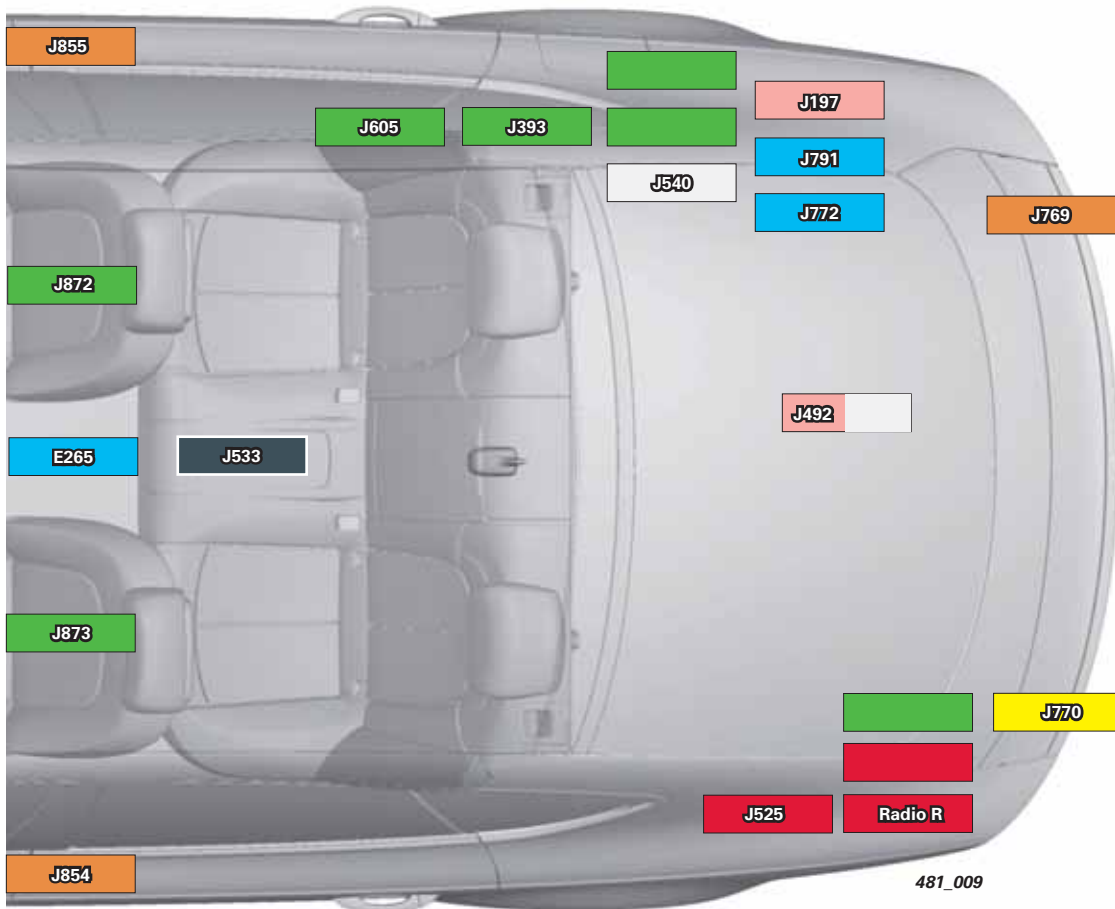

481\_009

- Control Modules on the Extended CAN bus**
- J745 Cornering Lamp and Headlamp Range CM
- J769 Lane Change Assistance Control Module
- J844 Automatic High Beam Assist Control Module
- J852 Camera Control Module
- J853 Night Vision System Control Module
- J854 Left Front Seat Belt Tensioner Control Module
- J855 Right Front Seat Belt Tensioner Control Module

- Control Modules on the MOST bus**
- J285 Instrument Cluster Control Module
- J525 Digital Sound System Control Module
- J794 Information Electronics Control Module 1
- R Radio
- R161 DVD Changer

- Control Modules on the FlexRay bus**
- J104 ABS Control Module
- J197 Level Control System Control Module
- J428 Distance Regulation Control Module
- J492 All Wheel Drive Control Module
- J500 Power Steering Control Module
- J849 Sensor Electronics Control Module
- J850 Distance Regulation Control Module 2
- J851 Image Processing Control Module

- Sub-Bus Users**
- R212 Infrared Camera
- J770 Lane Change Assistance Control Module 2

- Users of all Bus Systems (Gateway)**
- J533 Data Bus On Board Diagnostic Interface

# Topology

This diagram shows the network topology for a vehicle with an extensive level of optional equipment.

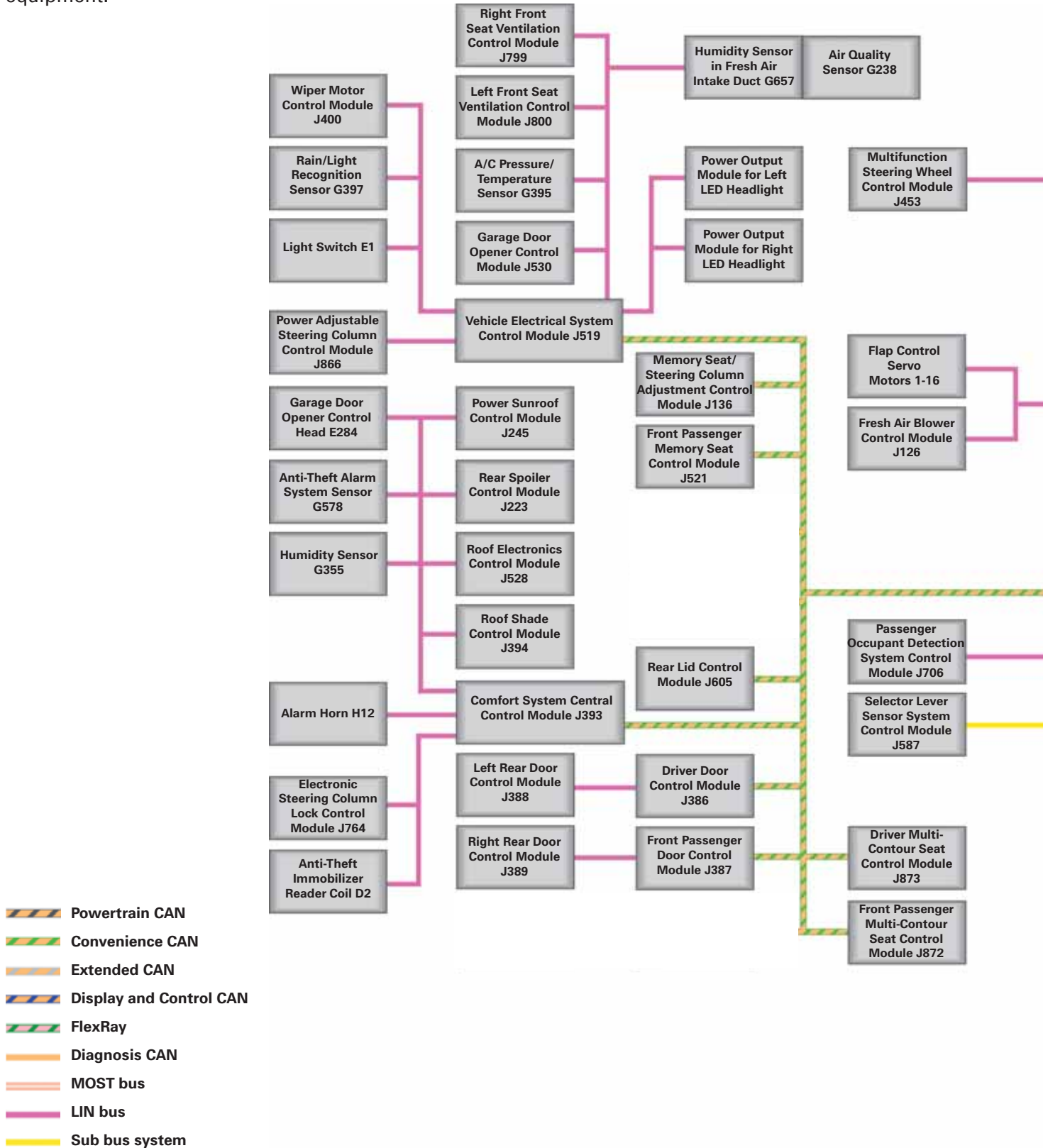

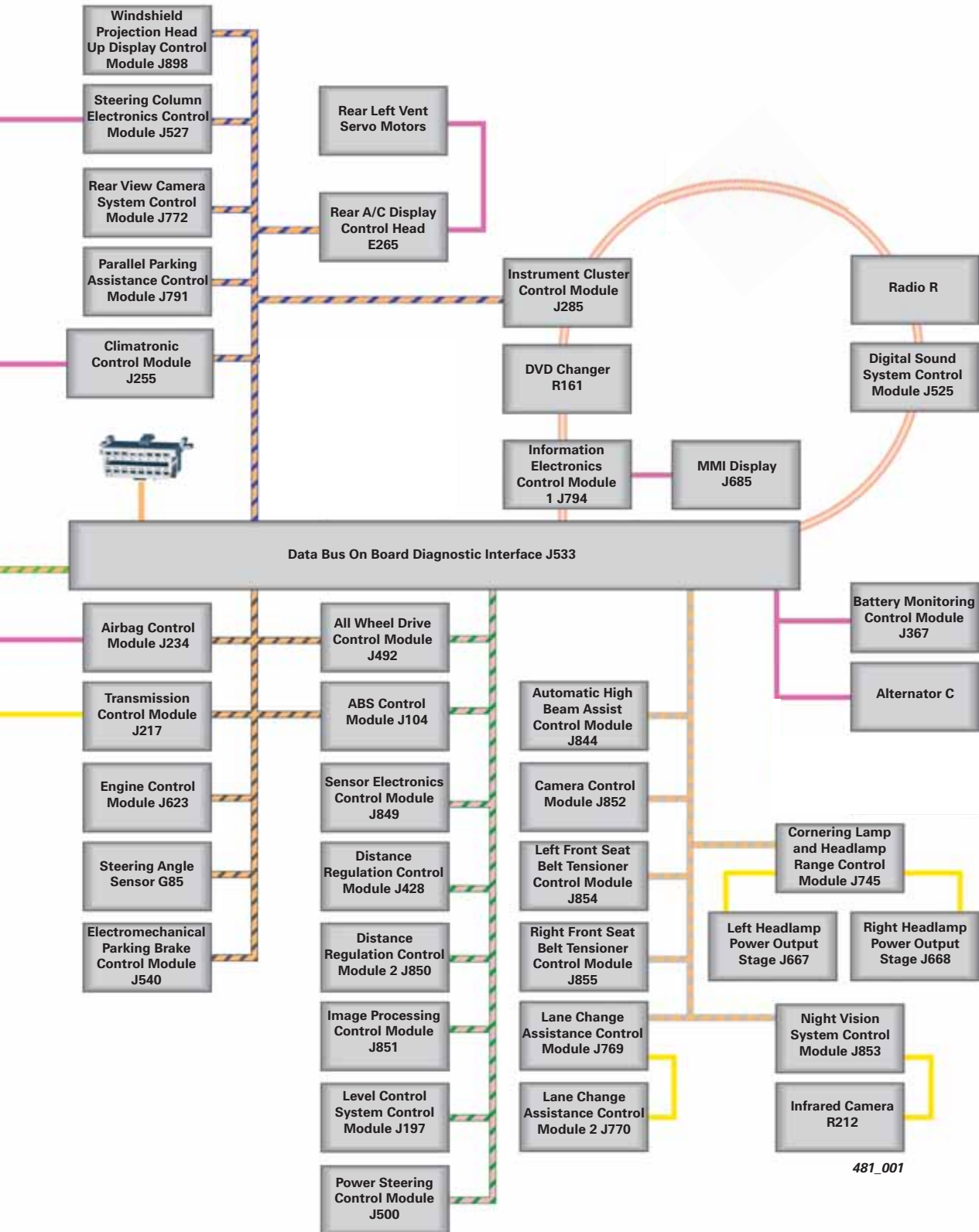

481\_001

# Exterior Lighting

## Light Switch

Summary Information	
Description	Light Switch E1
Installation Location	Driver's side, instrument panel
Functions	Communicates the driver's lighting setting request to the electrical system control module
Address Word	None, LIN slave, measured values, and diagnosis through Vehicle Electrical System Control Module J519 (master)



486\_048

### Function

The rotary knob has four settings:

0 Lights OFF (in some countries, daytime running lights are switched ON automatically at "terminal 15 on")

AUTO Automatic daytime running lights are switched ON and OFF depending on the light sensor

 Side light

 Low beam

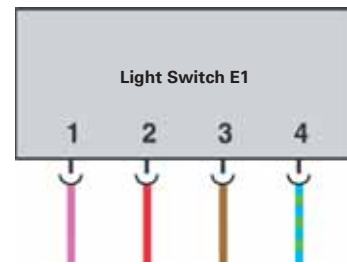

486\_094

Connections:

- Pin 1 LIN to J519
- Pin 2 "terminal 30"
- Pin 3 "terminal 31"
- Pin 4 Redundancy line to J519



486\_095

## Button Functions

The switch cluster on the left side of the light switch contains a maximum of three buttons:

- Using the upper button, either the fog lights (vehicles with halogen lights) or the all-weather lights (vehicles with bi-xenon or LED headlights) are activated
- Using the center button, the Night Vision Assist can be activated
- The bottom button is used to switch the rear fog light ON

Due to different equipment levels and country-specific regulations, the switch clusters differ and not all the buttons are active. Only the button for the rear fog light is used in all 2012 A6 models.



## Light Switch Symbols

 Fog lights (only for vehicles with Halogen headlights)

 All weather light (only for vehicles with Bi-xenon or LED headlights, not for North American market)

 Night Vision Assist

 Rear fog light

## Rotary Switch

A maximum of two rotary switches are located on the right side of the light switch:

- E376 Position Control for Head-Up Display (optional)
- E20 Instrument Panel and Switch Illumination Dimmer Switch (always installed)



## Headlights

Three headlight variants are offered in the 2012 A6:

- Halogen headlights
- Bi-xenon headlights
- LED headlights

The bi-xenon headlights are offered in the following versions:

- Bi-xenon
- Bi-xenon with adaptive light (AFS)

### Halogen Headlights



Light Function	Bulb Used	Power Output
Parking light	W5W	5 watts
Daytime running light (DRL)	H15	15 watts
Turn signal	3457A-58	30 watts
Low beam headlight	H7	55 watts
High beam headlight	H15	55 watts
Fog light (in bumper, not shown)	H7	55 watts
Coming home / leaving home	H7 and H15	55 and 15 watts
Side market lights	3 LEDs	approx. 2 watts

On vehicles with halogen headlights, the fog lights are built into the bumper. This precludes equipping these vehicles with Adaptive Cruise Control (ACC) because the space for the ACC sensors is occupied by the fog lights.

For the coming home/leaving home function, daytime running lights and fog lights are activated on vehicles with halogen headlights.



## Halogen Headlight Components

Headlight components such as caps, repair tabs, screws, and ventilation components can be replaced for all headlight variants on the 2012 A6. The individual components shown here can be replaced.



## H15 Halogen Bulb

The halogen headlight uses an H15 bulb for the daytime running lights and high beam functions. It is a dual-filament bulb with a 15-watt filament for DRLs, and a 55-watt filament for high beams.

Three contact tabs project from the base of the H15 bulb. They serve to make the electrical contact but also act as a mechanical stop when the bulb is turned to tighten when installing.

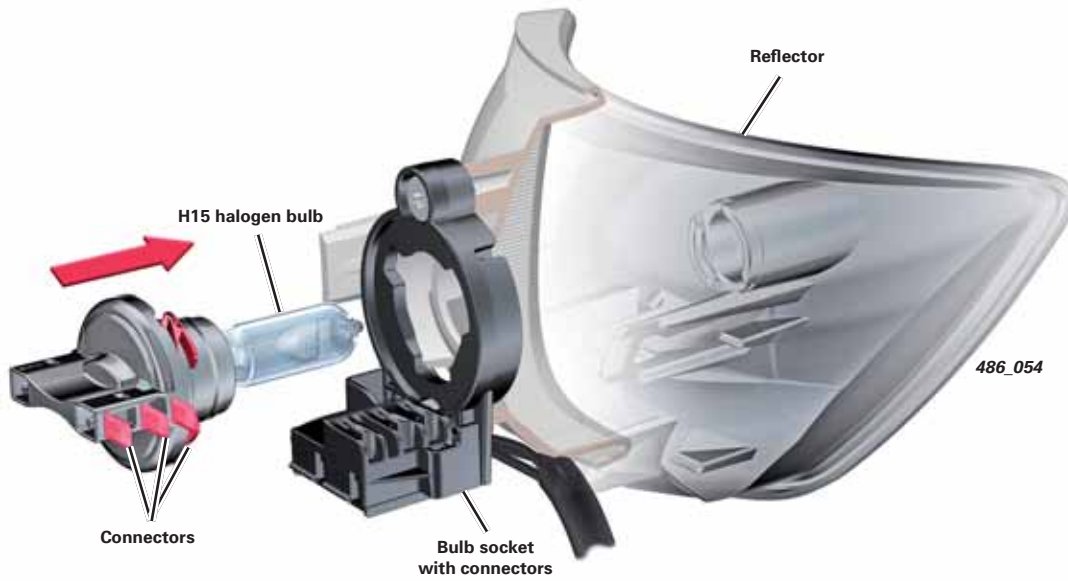

A quarter turn clockwise is sufficient to tighten the H15 bulb and complete the electrical contact. Clamps or bails are not required with the H15 bulb.

The H15 bulb can be installed in a single motion. This facilitates handling in the restricted space of the headlight housing.



## Bi-Xenon Headlights



Light Function	Bulb Used	Power Output
Parking light	2x3 LEDs dimmed (via 2 optical fibers)	not specified
Daytime running light (DRL)	2x3 LEDs (via 2 optical fibers)	not specified
Turn signal	PSY24W	not specified
Low beam headlight	D3S	24 watts
High beam headlight	D3S	35 watts
Coming home / leaving home	2x2 LEDs and gas discharge lamp D35	not specified
Side marker light	3 LEDs	approx. 2 watts

Neither the all-weather light function or fog lights are offered on vehicles with bi-xenon headlights in the North American market. The space for the ACC sensors is vacant on these vehicles, so it is possible to equip them with Adaptive Cruise Control (ACC).

The coming home/leaving home function uses the parking lights in conjunction with the low beams.

### Switching from Low Beams to High Beams

In the bi-xenon headlight, switching between low beams and high beams is done by a solenoid operated shutter.

In its normal position the shutter is raised for the asymmetrical low beams. The solenoid is energized for the high beam function, which lowers the shutter, producing the bi-xenon lamp's symmetrical light.

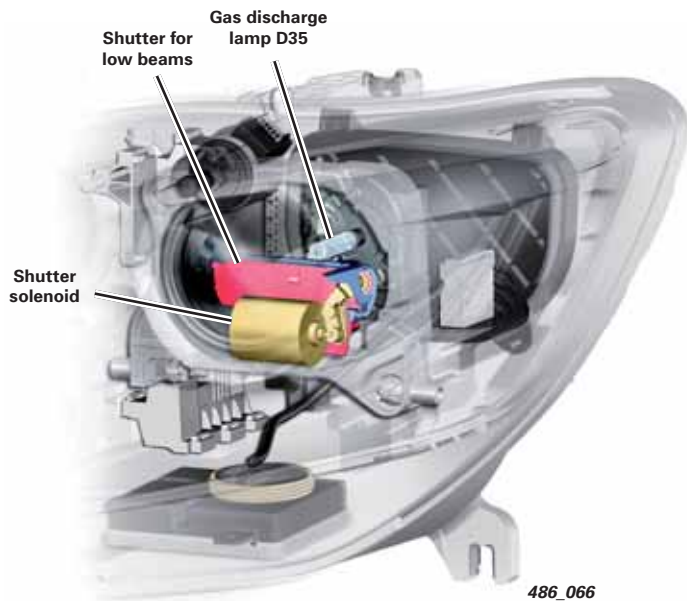

## Bi-Xenon Headlight Components

The individual components shown here can be replaced on a bi-xenon headlight.

The LEDs and the optical fibers for the parking light/daytime running light functions are not replaceable.



## Actuation

Actuation of the individual lights and of the control module for DRLs and Parking lights is performed separately by Vehicle Electrical System Control Module J519.

Actuation of headlight range control is performed separately by Headlamp Range Control Module J431.

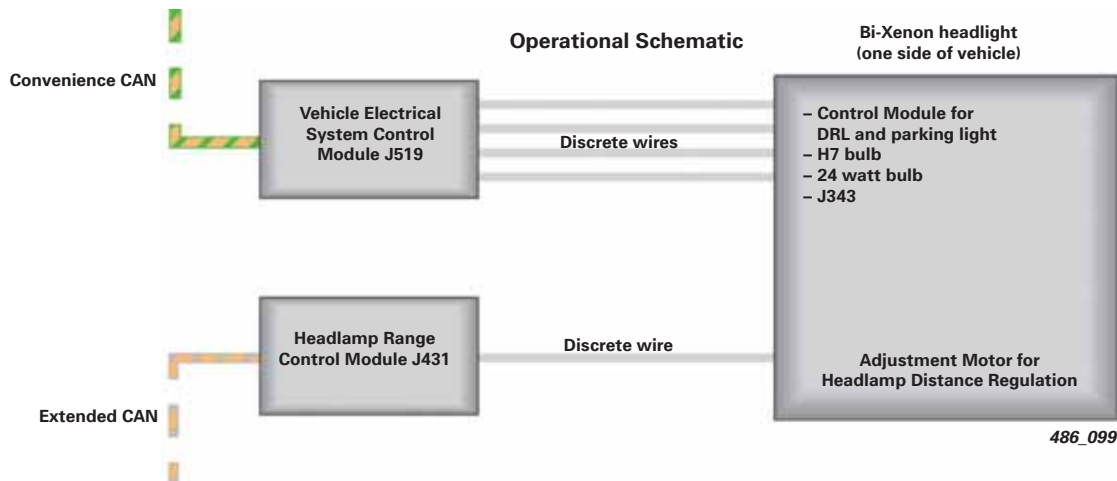

## Bi-Xenon Headlights with AFS



Light Function	Bulb Used	Power Output
Parking light	2x3 LEDs dimmed (via 2 optical fibers)	not specified
Daytime running light (DRL)	2x3 LEDs dimmed (via 2 optical fibers)	not specified
Turn signal	PSY24W	24 watts
Country light / highway light	D3S	35 watts
Low beam headlight	D3S	35 watts
Cornering light (static)	H7	55 watts
Coming home / leaving home	2x2 LEDs and gas discharge lamp D35	not specified
Side marker light	3 LEDs	approx. 2 watts

The all-weather light function is not offered on North American market vehicles with bi-xenon headlights and AFS. The installation space for the ACC sensors is vacant so Adaptive Cruise Control (ACC) is available.

The parking lights are used for the coming home/leaving home function in conjunction with the low beams.



### Reference

For further information about the head and tail lights of the 2012 A6, refer to Self-Study Program 990403, *The 2012 Audi A7 Onboard Power Supply and Networking*.

## Bi-Xenon Headlight with AFS Components



### Actuation

Vehicle Electrical System Control Module J519 actuates the control module for the DRLs and parking lights, the control module for the gas-discharge lamp, the H7 bulb, and the 24-watt bulb separately.

Cornering Lamp and Headlamp Range Control Module J745 actuates the power module for headlights over a private CAN.

Left Headlamp Power Output Stage J667 actuates the adjusting motor for the roller, the servo motor for headlight range control and the servo motor for the dynamic cornering light.

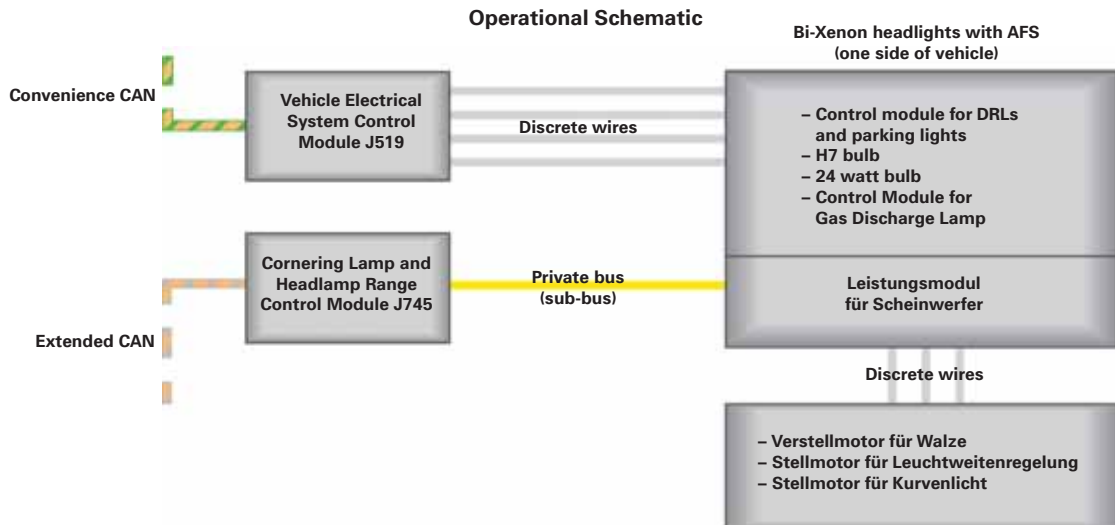

486\_100

## LED Headlights

The LED headlights of the A6 feature LEDs for lighting functions. Each headlamp has a total of 57 LEDs together with accompanying heat sinks. A fan integrated into the headlight prevents the electronic components from overheating.

Reflectors or projection modules are used, depending on the lighting function. Thick-walled optics are employed for the DRLs, parking lights, and turn signals to achieve a homogenous appearance for these lighting functions.

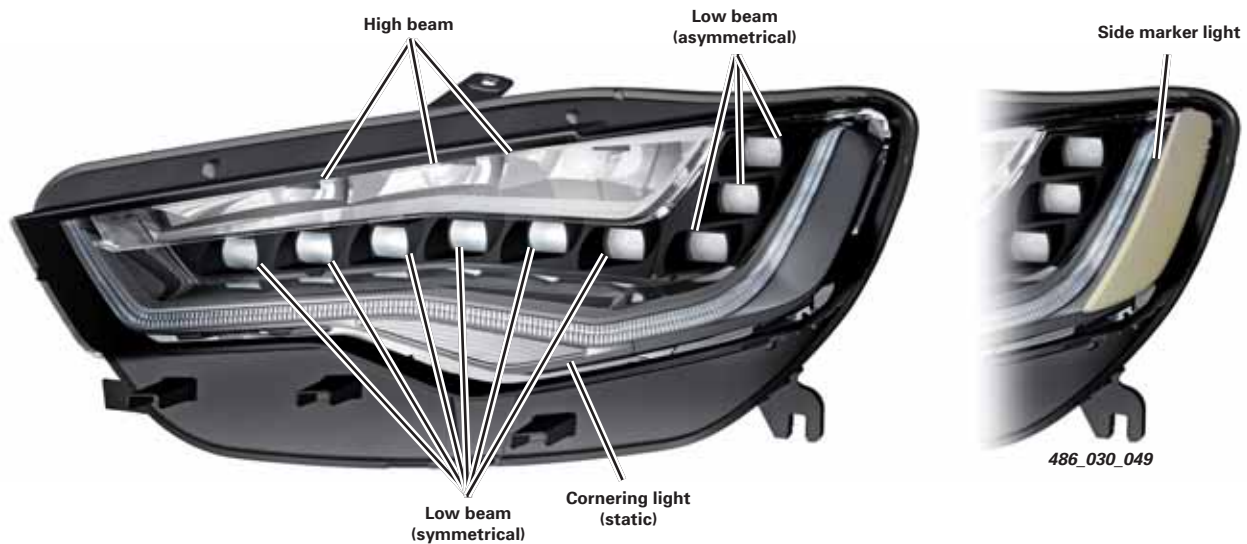

Light Function	LEDs Used
Parking light	LEDs (white, dimmed)
Daytime running light (DRL)	LEDs (white)
Turn signal	2x2 LEDs
Low beam headlight	14 LEDs (5x2 chip and 4 single LEDs)
High beam headlight	12 LEDs (3x4 chip, in addition to low beams)
Cornering light (static)	4 LEDs (1x4 chip, in addition to low beams)
Coming home / leaving home	14 LEDs (5x2 chip and 4 single LEDs)
Side marker light	3 LEDs (white with yellow reflector)

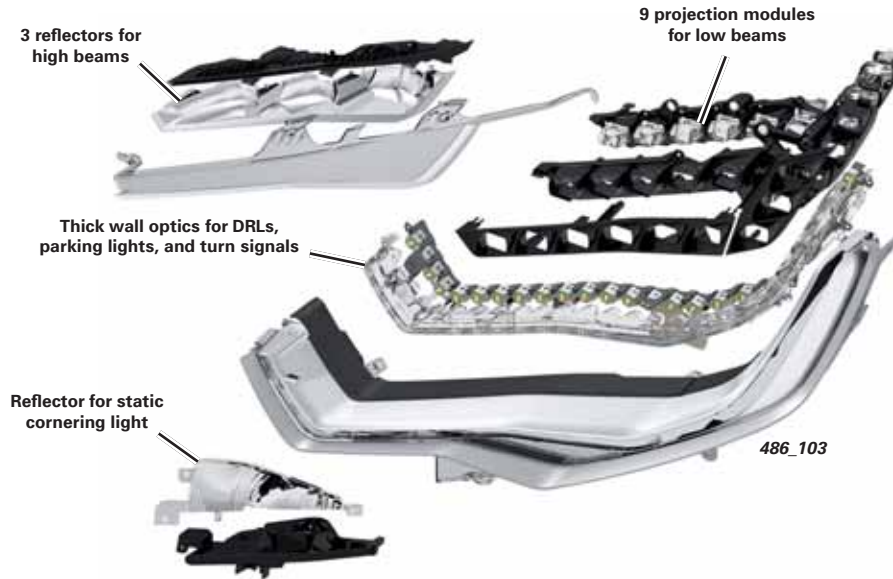

### DRLs / Parking Lights

The DRLs and parking lights consist of 24 white LEDs. They are activated by a pulse-width modulated signal (PWM). The LEDs are operated in a dimmed state for the parking light function.



486\_104

### Turn Signals

The turn signal is comprised of 24 yellow LEDs. During turn signal operation, the LEDs for the DRLs are dimmed to the level of the parking light.



486\_105

### Low Beam Headlights

Nine projection modules with a total of 14 LEDs are used for the low beams. The LEDs for the DRLs are dimmed to the level of the parking light.

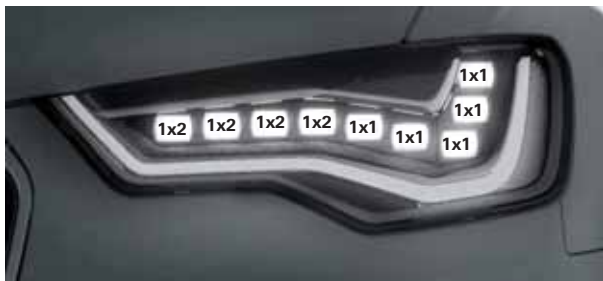

486\_106

### High Beam Headlights

Three quadruple chips are activated for the high beam function in addition to the LEDs for the low beams and parking lights.

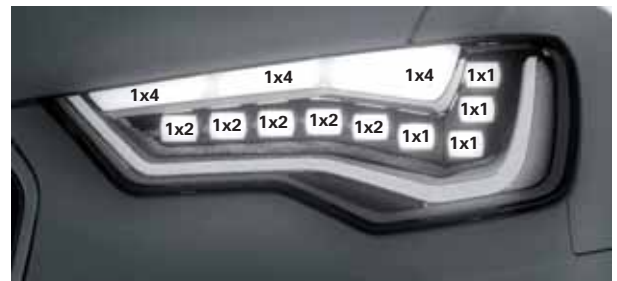

486\_107



### Cornering Light (static)

A quadruple chip below the parking light is activated in addition to the low beam function for the static cornering light. These LEDs are provided with a reflector which illuminates the area to the side of the vehicle when turning.

This light is activated either by the turn signal and a speed below 25 mph (40 km/h), or a wide steering angle at a speeds below 44 mph (70 km/h).

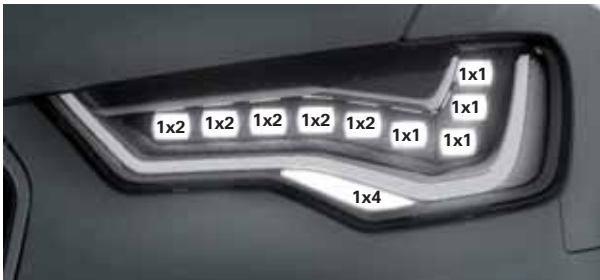

486\_109

### Coming Home / Leaving Home

The same LEDs that create the low beam are used for the coming home/leaving home lighting functions. These functions are activated either when exiting the vehicle by opening the driver's door, or when unlocking the vehicle with the radio remote key. Light Switch E1 must be in the "AUTO" position, Rain/Light Recognition Sensor G397 must recognize darkness, and both functions must be enabled in the MMI.

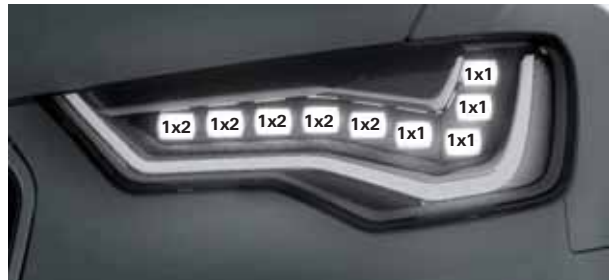

486\_106

## LED Headlight Components

The individual components shown here can be replaced separately in the LED headlight.

LED groups or individual LEDs cannot be replaced in the LED headlight.



## Actuation

Power modules 2 and 4 are energized over separate lines by Vehicle Electrical System Control Module J519. Power modules 1 and 3 are LIN slaves of J519.

Power module 1 A31 controls the fan in the LED headlight over separate lines. The fan is activated with "terminal 15 on" and runs permanently until terminal 15 is switched OFF.

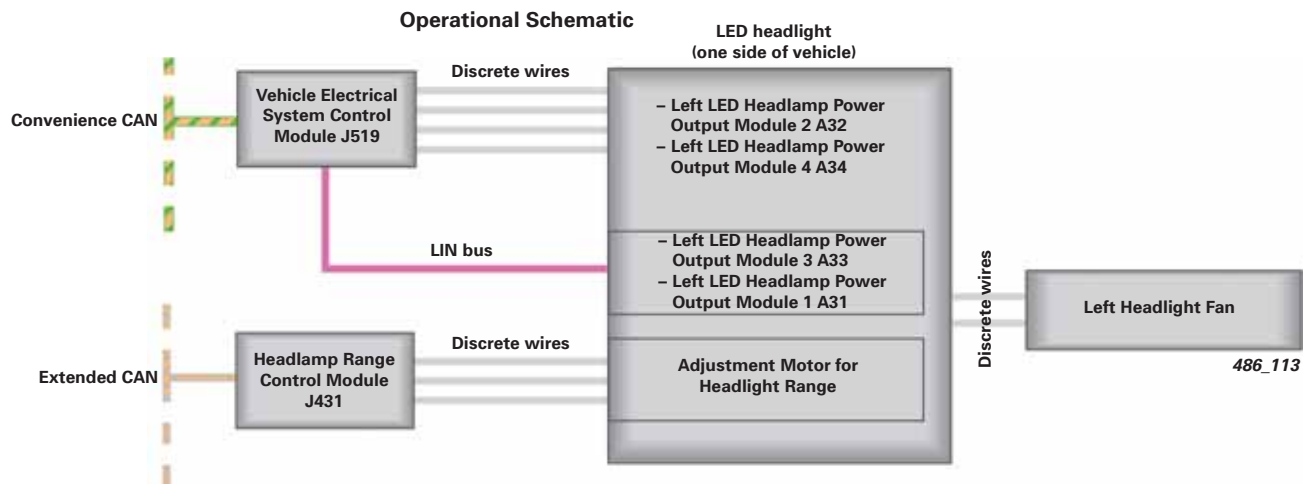

### Note

When replacing components of the LED headlights, always use VAS 6613 to prevent ESD.

## Rear Lights

### LED Rear Lights

Almost all rear light functions utilize LED technology. The only exceptions are the back-up lights, which use a 16-watt bulb, and the rear fog light, which uses a 21-watt halogen bulb.

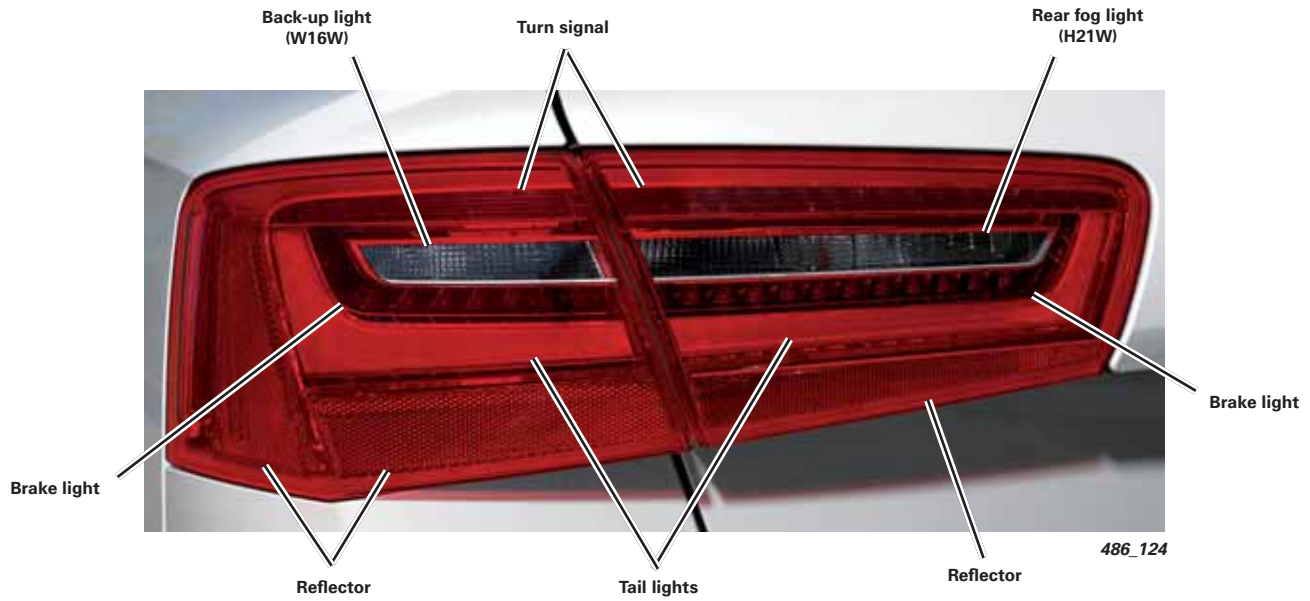

# Rear Lights at Night

## Tail Light

The LEDs also have an optical fiber to reinforce the impression of a continuous band of lights from all angles.



486\_117

## Brake Light (combined with tail light)

The brake light is comprised of 45 LEDs.



486\_119

## Turn Signal (combined with tail light)

The turn signal is comprised of 45 LEDs that are also employed for the brake light function.



486\_121

## Fog Light with Tail and Brake Light

This configuration ensures that the two lighting functions can be clearly differentiated. It also maintains the legally mandated minimum distance between the brake light and the fog light.



486\_123

## Light Functions not Illustrated

### Backup Light

A 16-watt bulb is used for the backup light. The backup light function operates only in the quarter panel light.

### High Mounted Brake Light

The 2012 A6 has a center high-mounted brake light at the upper edge of the rear window. This light supplements the brake light function comprised of 18 LEDs

Light Function	Type
Tail light	30x LED
Brake light	45x LED
Turn signal	45x LED
Rear fog light	1x H21W, 21 Watt
Backup light	1x W16W, 16 Watt
High mounted brake light	18x LED
Side marker light	2x LED

# Climate Control

## Overview

### Climate Control System Versions

Three-zone and four-zone climate control systems are available on the 2012 A6.

On the three-zone system, rear passengers can adjust the temperature via a button located on the rear center console.

Two humidity sensors, Humidity Sensor in Fresh Air Intake Duct J657 and Humidity Sensor G355 are used in both the three- and four-zone systems.

The four-zone system also has Rear A/C Display Control Head E265 with the following functions:

- Temperature adjustment
- Fan adjustment
- Separate rear left and right air distribution adjustment

To provide climate control in the rear, the four-zone system has air outlets in the B-pillars. The four-zone climate control system has the following features:

- Automatic recirculation control by Air Quality Sensor G238
- Residual heat function
- Separate footwell temperature control
- Glove compartment cooling system
- Three different air conditioning modes: soft, medium, and intensive

### Three-Zone Climate Control System



### Four-Zone Climate Control System



#### Reference

For further information about the climate control systems of the 2012 A6, refer to Self-Study Program 990603, *The 2012 Audi A7 Occupant Protection, Infotainment, Climate Control, and Head-Up Display*.

Introduction

The 2012 A6 comes equipped with the MMI Radio plus or the MMI Navigation plus system, depending on vehicle model level.

MMI Radio plus



484\_070



484\_067

MMI Navigation plus



484\_065



484\_069

Topology

The A6 Infotainment control modules communicate over the MOST bus. This allows very high data transfer rates.

Picture signals from the back-up camera or DVD changer are transmitted as FBAS signals to Information Electronics Control Module 1 J794.

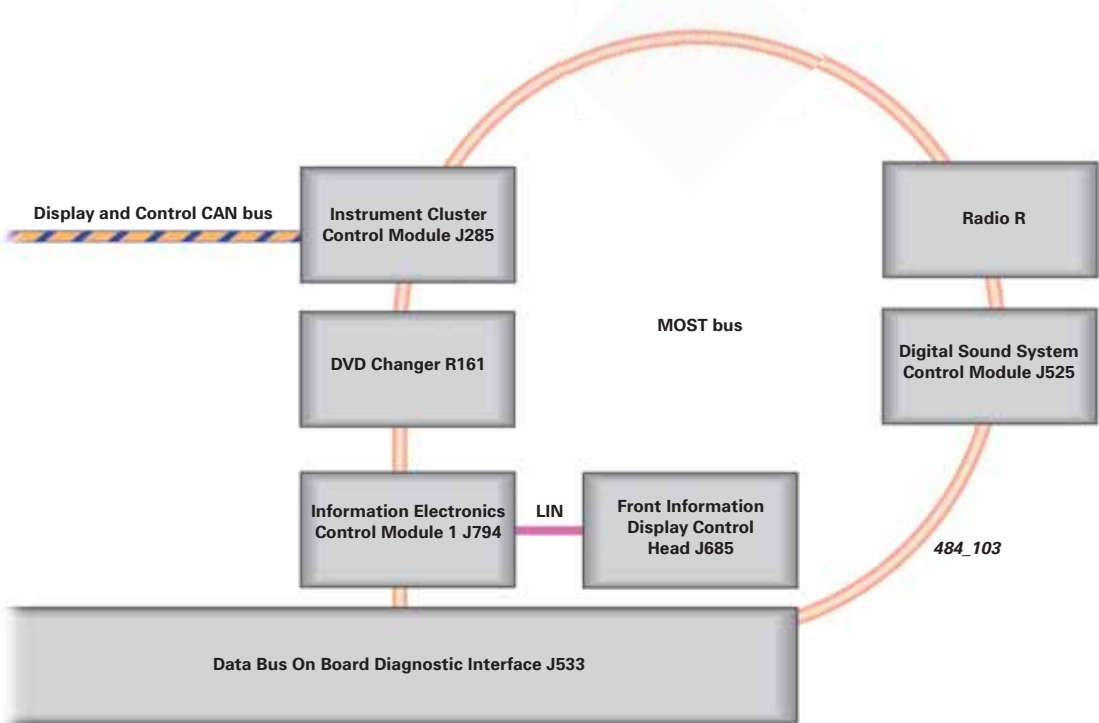

484\_103

## Radio Media Center (RMC)

The MMI Radio plus system belongs to the Radio Media Center infotainment platform.

Depending on equipment level, the Radio Media Center combines nearly all the hardware functions of a modern infotainment system in a single housing, which is the equivalent of a 1-DIN device. The RMC is also central controller for the infotainment system.

The main difference in the RMC with the third generation MMI system is that there is no separate radio control module. The functions of the radio are integrated into Information Electronics Control Module 1 J794. On vehicles with MMI Radio plus, J794 has an additional audio amplifier.

Radio diagnosis with the VAS Scan Tool is done through Address Word 5F – Information Electronics Control Module 1 J794.

Front panel of J794 for MMI Radio plus



## RMC Control Modules

This illustration below shows which control modules and functions are grouped within Information Electronics Control Module J794 of the Radio Media Center.

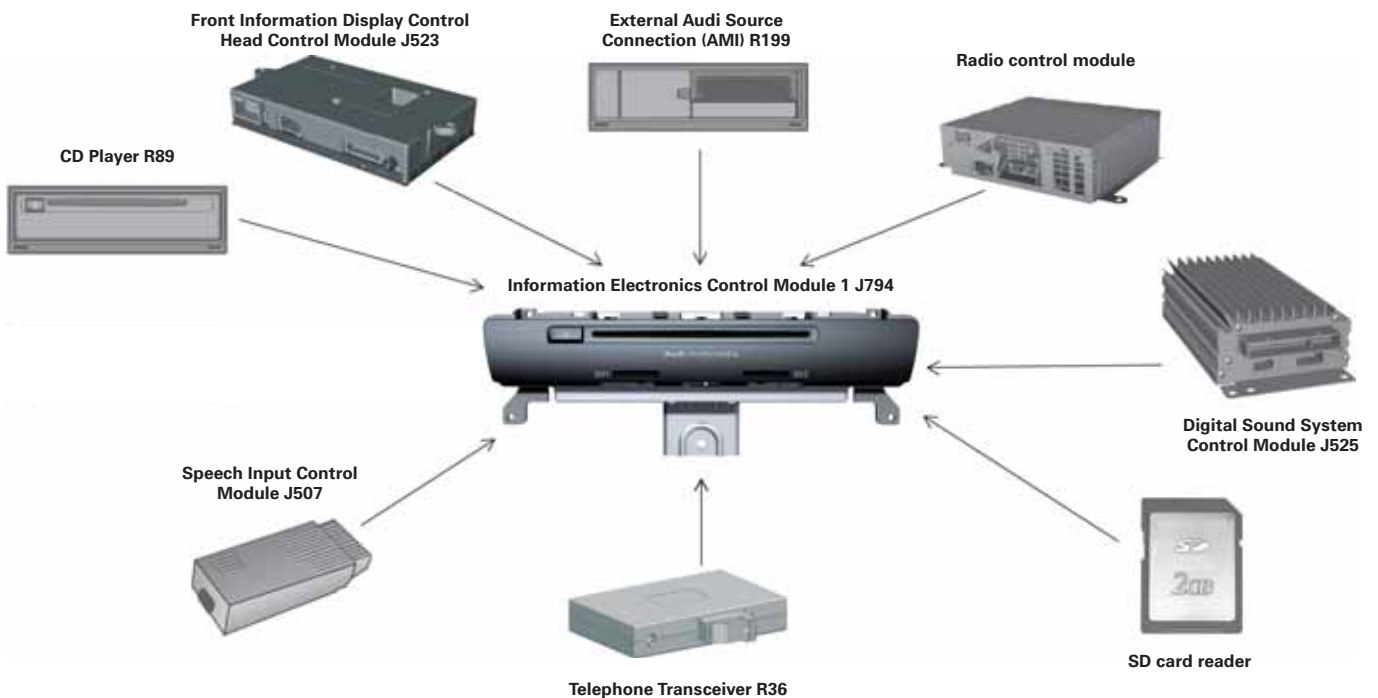



## MMI Radio Plus (RMC)

MMI Radio plus has the following features:

- Two SD card readers
- Integrated six-channel amplifier for the Audi Sound System with 180 watts power output
- Bluetooth interface
- Speech dialogue system
- Driver Information System (DIS) with monochrome screen in the instrument cluster
- Digital satellite radio
- AUX in on center console
- Compatible with optional equipment
- 6.5-inch color display with 400 x 200 pixel resolution
- Control panel with six freely assignable radio station keys
- FM tuner with dual diversity

With MMI Radio plus, the CD drive and the SD card reader support playback of the following audio files:

- MP3
- WMA
- AAC
- WAV

The metadata in these files (album, track, artist, etc.) and the embedded album cover can also be displayed.

### Bluetooth Interface

The MMI Radio for the A6 comes with a Bluetooth interface, which enables the RMC to be used for the hands-free telephone and audio streaming.

The Bluetooth HFP profile is used for the hands-free telephone and A2DP for audio streaming. The AVRCP profile is used to control the audio player connected via Bluetooth. The scope of the control options is dependent upon the device in use.

Front panel of J794 for MMI Radio plus



Back panel of J794 for MMI Radio plus

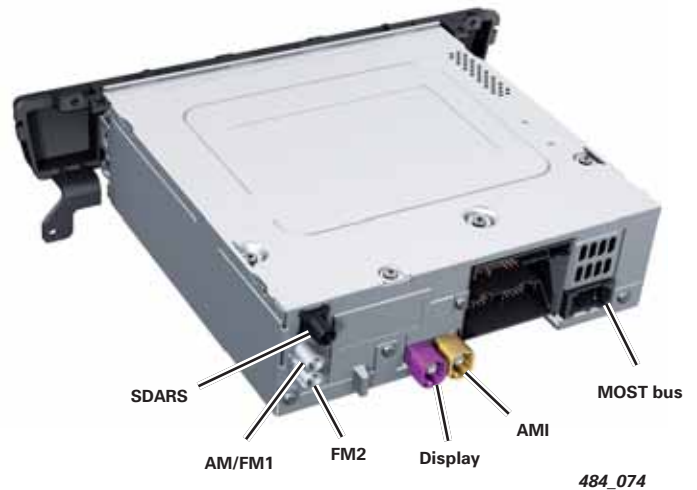

### Speech Dialogue System

MMI Radio plus comes with an integrated speech dialogue system, which can be used, among other things, for the hands-free telephone or for selecting a radio channel. The main functions of the RMC can be operated by voice control (for example, find a contact in a directory, dial a number, etc.).

## MMI Navigation Plus

The MMI Navigation plus system is identical to the system of the 2011 A8. It is a third generation MMI system with the internal designation MMI3G plus. MMI Navigation plus features the following:

- 60 GB hard drive (with approximately 20 GB for Jukebox)
- 3D navigation with 3D city models
- DVD drive
- Two SD card readers (for SDHC cards up to 32 GB in size)
- Premium speech dialogue system
- Radio control module with phase diversity
- Six-channel amplifier with 180 watts power output (integrated into the radio control module)
- 8-inch TFT screen with 800 x 480 pixel resolution
- Driver information system with 7-inch color screen in the instrument cluster
- MMI touch
- Bluetooth interface for:
  - Hands-free telephone (HFP)
  - Audio streaming (A2DP)

The A6 with MMI Navigation plus also includes the following standard equipment:

- Audi Music Interface
- Audi Connect (WLAN hotspot)
- Digital satellite radio tuner

Front panel of J794 for MMI Navigation plus



484\_069

Back panel of J794 for MMI Navigation plus

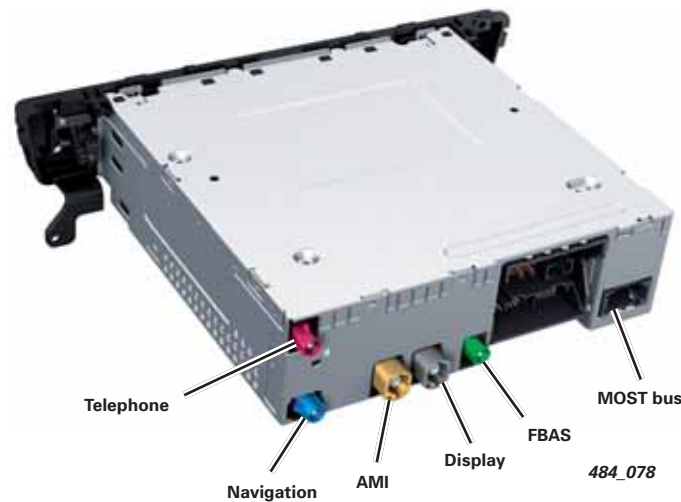

484\_078

## New Features of MMI Navigation Plus – Audi Connect

### Google Earth Map

The 3D map display can be expanded to include satellite mapping via Google Earth.

The 3D satellite map display is produced by combining the 3D map display with the existing 3D topographical display. This function is only available in combination with Audi Connect and an active data link.

### WLAN Hotspot

The A6 has a WLAN hotspot in combination with Audi Connect. Passengers with suitable devices can use the WLAN hotspot to surf the Internet, retrieve data or e-mails or, for example, to conveniently and securely download the latest apps for an iPad.

When a network link is active, it is indicated at the bottom right of the display. 2G is displayed for GSM network and 3G for UMTS network.

The Universal Mobile Telecommunications System (UMTS) is a third generation (3G) mobile communications standard which provides for significantly higher data transfer rates (up to 7.2 Mbit/s with HSDPA [High Speed Downlink Packet Access] and up to 384 kbit/s without) than the second generation (2G) mobile communications standard, the GSM Standard (up to 220 kbit/s with EDGE and max. 55 kbit/s without).

3D satellite map



484\_079

Network connectivity display

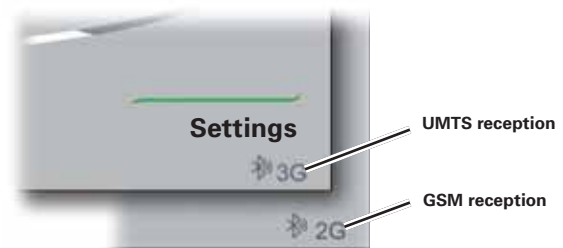

484\_081



### Note

The final operational features and graphic displays for Audi Connect and Google Earth may differ from those presented here. Always check appropriate literature for the latest information.

## Google Earth Mapping

If the Google Earth variant is active, the satellite maps are loaded directly from the Internet (currently from Google Earth). This satellite map is combined with the navigation map on the hard drive to produce a 3D satellite map.

The prerequisites for use of Google Earth maps are:

- MMI Navigation plus
- Audi Connect
- Data capable SIM card

### Loading Google Earth Maps

The following requirements must be met in order to load mapping material from Google Earth:

- T-Mobile SIM card inserted in the card reader
- Active Audi Connect account
- Configured data link

Also, in the "Settings" menu of the navigation system:

- Map type must be set to "Position 3D"
- Map display must be set to "Google Earth"

If these requirements are met, Information Electronics Control Module 1 J794 always loads the satellite map for the current location and the expected route. The loaded data packets are cached on the hard drive, where the current map view is then unpacked and displayed.

If enough data packets are stored for a certain route because the user travels this route on a daily basis, a 3D satellite map can be displayed even without an active link to Google Earth.

If there is not enough data in the cache to display a map of adequate quality on the MMI screen, the system informs the user and switches to the standard map.

Google Earth home page

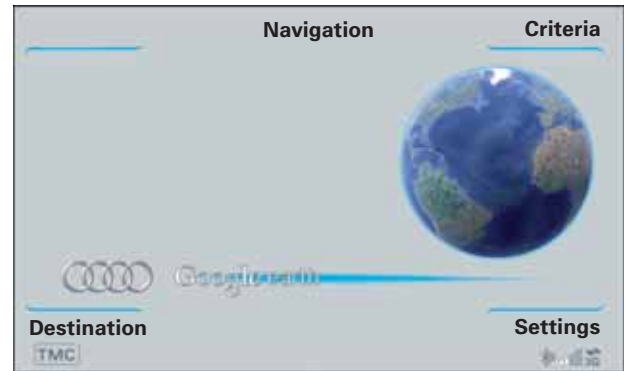

484\_082

Settings for Google Earth

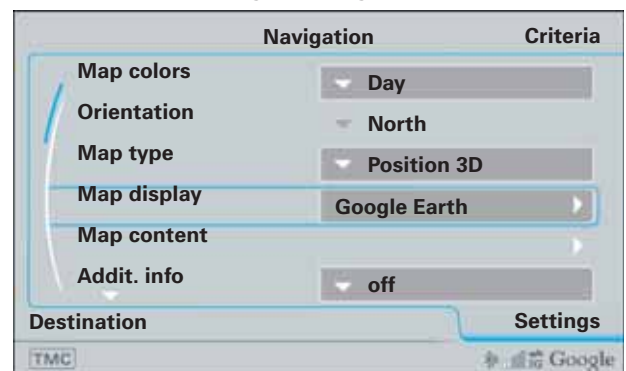

484\_083

3D satellite map

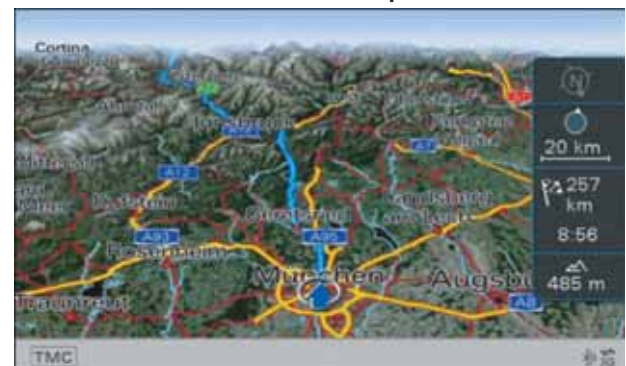

484\_079

This message is displayed if too little data is available

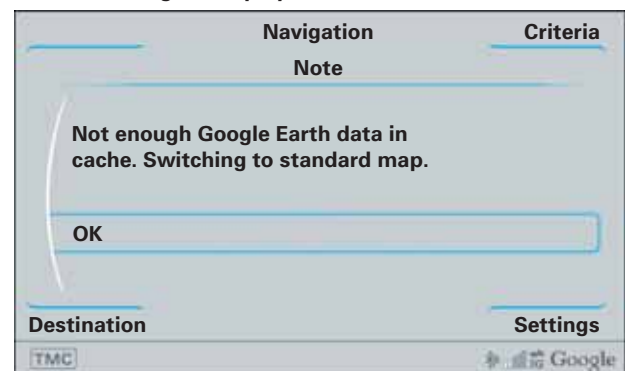

484\_084



#### Note

The final operational features and graphic displays for Audi Connect and Google Earth may differ from those presented here. Always check appropriate literature for the latest information.

## WLAN Hotspot

Wireless high-speed internet access is made possible via WiFi connectivity technology, which provides a link between WLAN (wireless local area network) hotspots and multiple devices.

A hotspot is a location which offers public Internet access via a wireless network. Unlike a regular WLAN network, the devices usually do not have to be linked to one another or networked. They are linked separately to the hotspot. Like most public hotspots, Audi also uses the IEEE802.11b/g wireless standard for transmitting data.

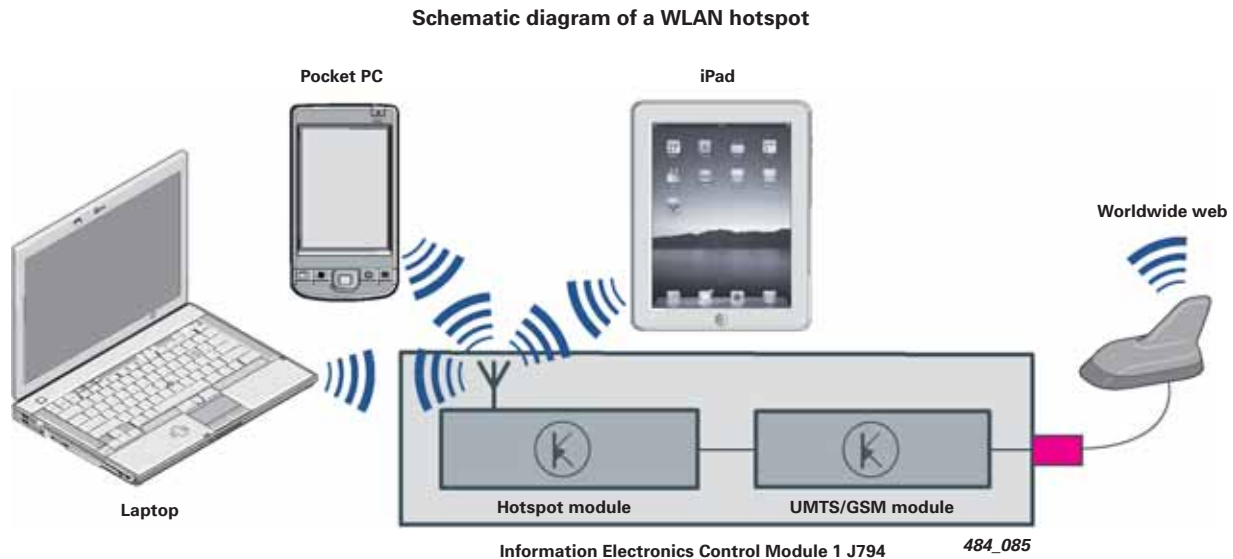

## WLAN on the Audi A6

Audi Connect is required to implement the WLAN hotspot. It transforms the A6 into a full-fledged office on wheels. Up to eight devices (for example, iPads, laptops, PDAs, etc.) can be linked to the hotspot. The reception range is confined to the interior of the vehicle.

The WLAN hotspot is installed with the following equipment combination:

- MMI Navigation plus
- Audi Connect

The control module required for the WLAN hotspot is integrated in Information Electronics Control Module 1 J794. The hotspot can also be used for connecting suitable devices via WLAN.

The UMTS module connects the device to the Internet via the vehicle's external aerial. The UMTS module is built into J794. Maximum download speed is 7.2 Mbit/s.

The following Internet connectivity requirements must be met:

- T-Mobile SIM card inserted in the card reader
- Active Audi Connect account
- Configured data link



### Note

The final operational features and graphic displays for Audi Connect and Google Earth may differ from those presented here. Always check appropriate literature for the latest information.

## Setting up a Data Link to the Internet

When a data link is set up for the first time, it is configured automatically. If this fails, the following values must be entered manually in the telephone submenu "Data connection" under "Connection settings":

- APN (access point)
- User name
- Password
- Authentication

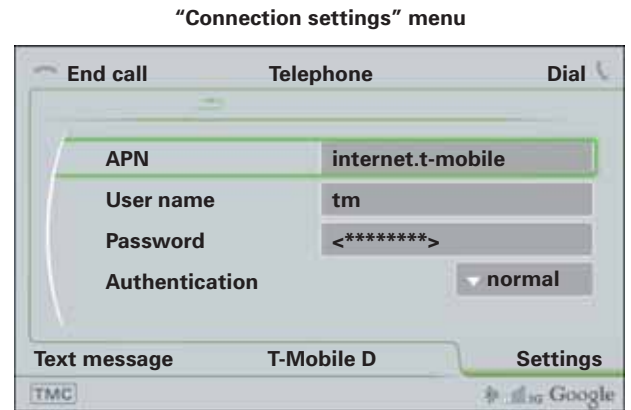

## Connecting a WLAN Device

To connect the device, the car phone must be in operation. To connect a WLAN device to the hotspot for the first time, the following values must be entered into the device:

- Access point (SSID) — name of WLAN network
- Encryption type — WEP, WPA or WPA2
- Password
- Discoverability ON

The following values can be changed individually in the "WLAN settings" submenu. Likewise, the same values must be entered into the WLAN device.

The "WLAN settings" submenu can be accessed via the following menu options:

- Telephone
- Settings
- Connections
- Network connection (WLAN)
- WLAN settings

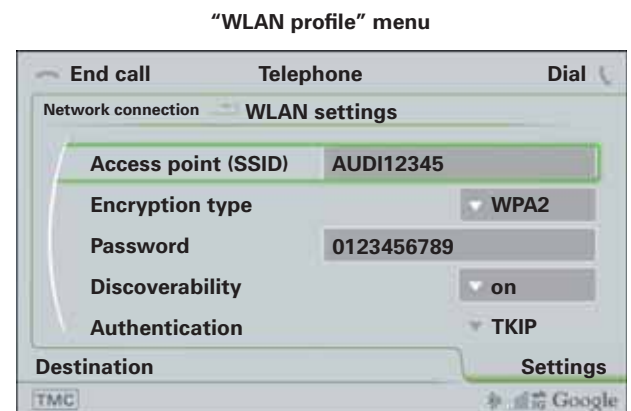

### Note

The final operational features and graphic displays for Audi Connect and Google Earth may differ from those presented here. Always check appropriate literature for the latest information.

## Operating Unit

### Multimedia System Control Head E380

Two versions of E380 are used on the A6. Vehicles equipped with MMI radio plus have a six button keypad for selecting radio presets. On vehicles with the MMI Navigation plus, a touchpad is standard equipment.

E380 has been redesigned for the A6, and is different from the E380 found on the 2011 A8. The "Info" and "Tone" buttons have been eliminated. However, these two functions are still available in the main menu.

E380 is connected to Information Electronics Control Module 1 J794 via a serial RS232 port. E380 is also responsible for activating the MMI display. It is diagnosed via J794 using Address Word 5F.

Operating unit for MMI Radio plus



484\_089

Operating unit for MMI touch



484\_089

### Button Combinations for Service Work

E380 has modified button combinations for system reset functions and for activating the Engineering menu.

#### System Reset

To reset the MMI system, the following buttons must be pressed briefly at the same time:

- Turn-push button
- Softkey at top right
- MENU

Button combination for system reset



484\_092

#### Engineering Menu

To access this menu, the following buttons must be pressed one after the other and held down:

- CAR
- BACK

Button combinations for the Engineering menu



484\_093

## MMI Display

### Front Information Display Control Head J685

Two different displays are used on the A6, depending on vehicle model level. They differ from one another in terms of their size and resolution.

The display is connected to Information Electronics Control Module 1 J794 by a 4 pin connector.

The various features of the display are listed below.

#### 6.5-inch MMI Display

The 6.5-inch display is a TFT color screen with ¼ VGA resolution. This is equivalent to 400 x 240 pixels. It comes standard with the MMI Radio plus system.

Two of the four wires are used for transferring images via LVDS, and one is used for transferring data via the LIN bus. The fourth wire provides a ground circuit.

The display is supplied with electrical power via a separate connector.

#### 8-inch MMI Display

The 8-inch display is a TFT color screen with VGA resolution. This is equivalent to 800 x 480 pixels. It comes exclusively with MMI Navigation plus.



484\_095



484\_094



## MMI Display Swivel Mechanism

A cable pull drive is used to raise and lower the MMI display.

The swivel mechanism has the following parts:

- Display Opening/Closing Motor V301
- Display –Open– Stop Switch F330
- Display –Closed– Stop Switch F331
- Cable pull
- Spring tensioning elements
- Guide track
- Driving gear

## Design

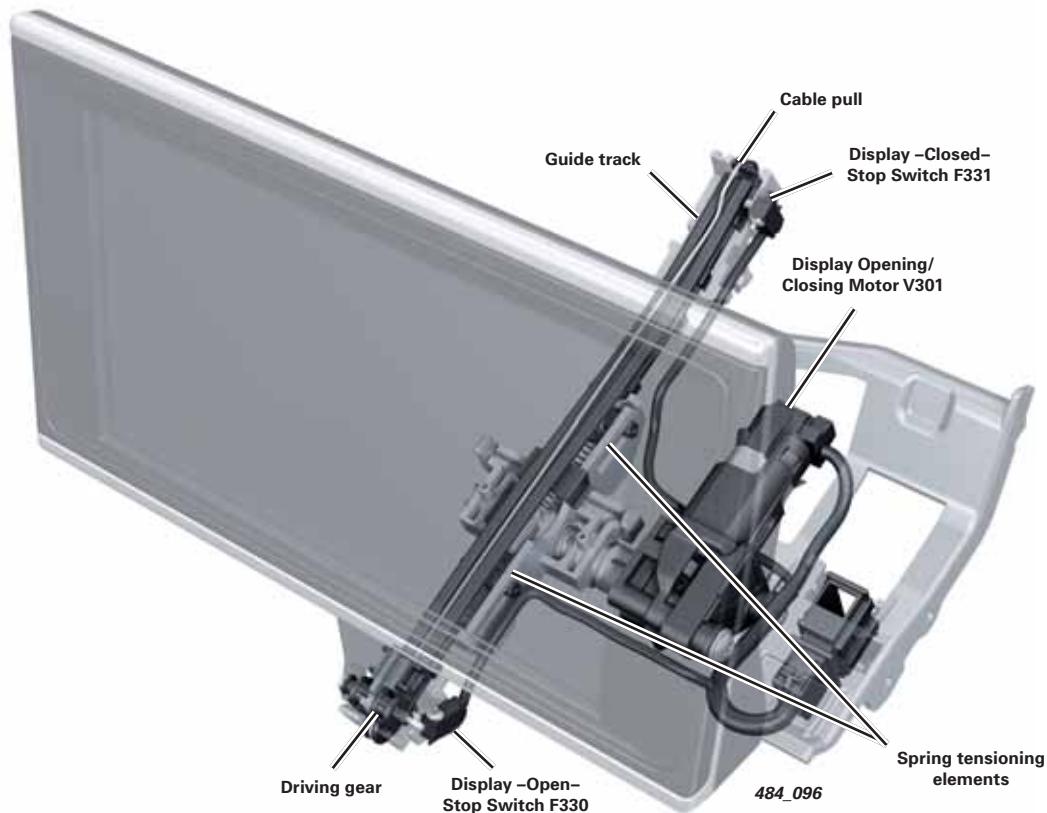

## Operation

When the display is opening, V301 drives the pulley. The cable is retracted below the driving gear and unreeled above the driving gear. The driving gear moves down.

The display mount is firmly attached to the driving gear and is swiveled downward, opening the display.

## Activation Mechanism

The motor and both limit switches are activated and evaluated by Multimedia System Control Head E380.

## Service Position

The display must be placed into a service position before it can be removed. During this process, the driving gear is moved to within a defined distance of Display –Closed– Stop Switch F331

This prevents damage to F331 during removal. The display is moved into the service position using Guided Fault Finding.

## Sound Systems

Three sound systems are offered for the A6. Sound system availability is vehicle model dependent. They are:

- The Audi Sound System
- The Bose Surround Sound System
- The Bang & Olufsen Advanced Sound System

### Bose Surround Sound System

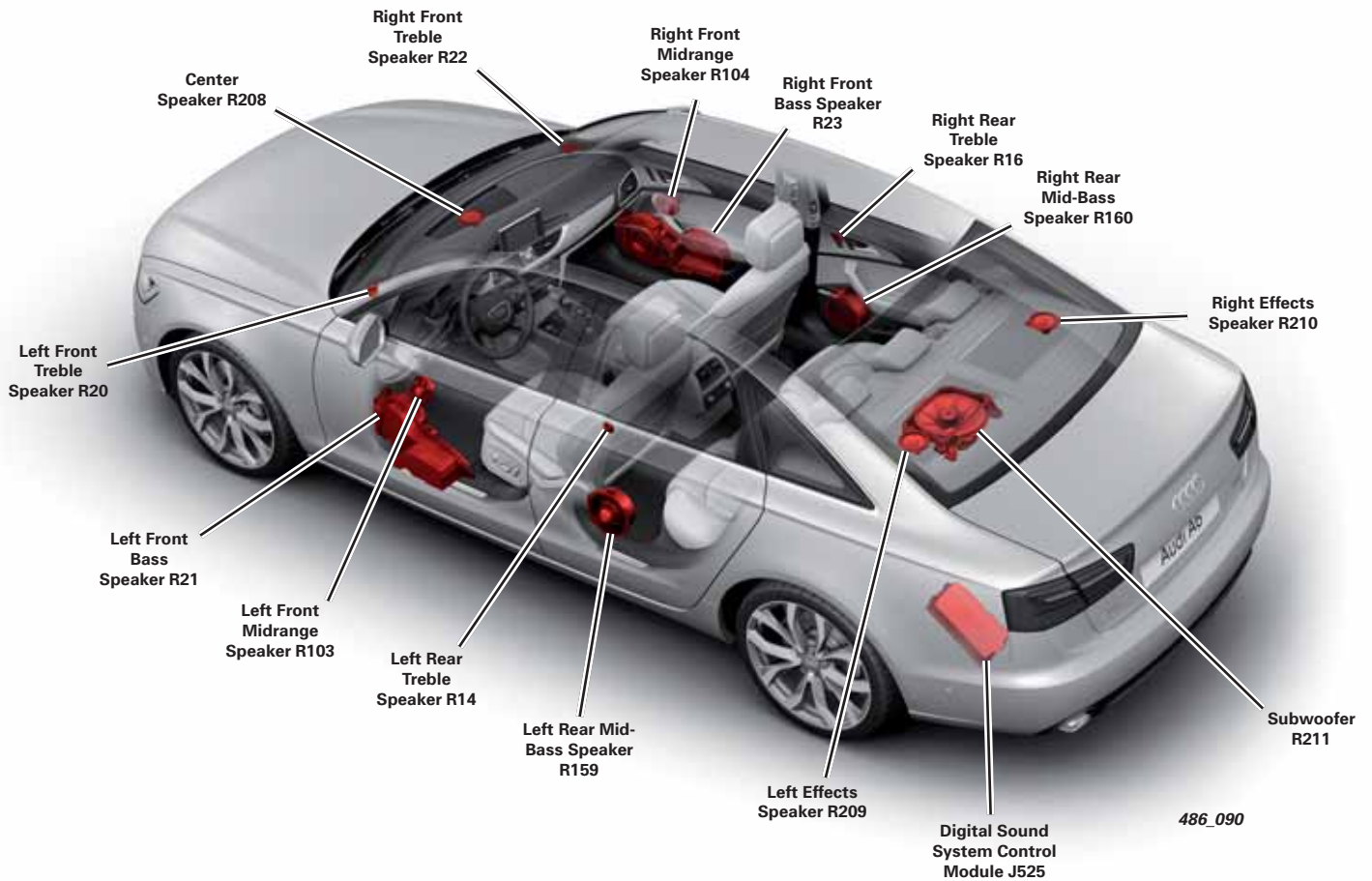

## Bang & Olufsen Advanced Sound System

The Bang & Olufsen Advanced Sound System uses 15 loudspeakers and two amplifiers. They create a sense of space resembling the ambience of a concert hall.

Both amplifiers supply the loudspeakers with 1300 watts total RMS output power. Retractable tweeters in the instrument panel set the stage for a perfect production.

**Bang & Olufsen Sound System**

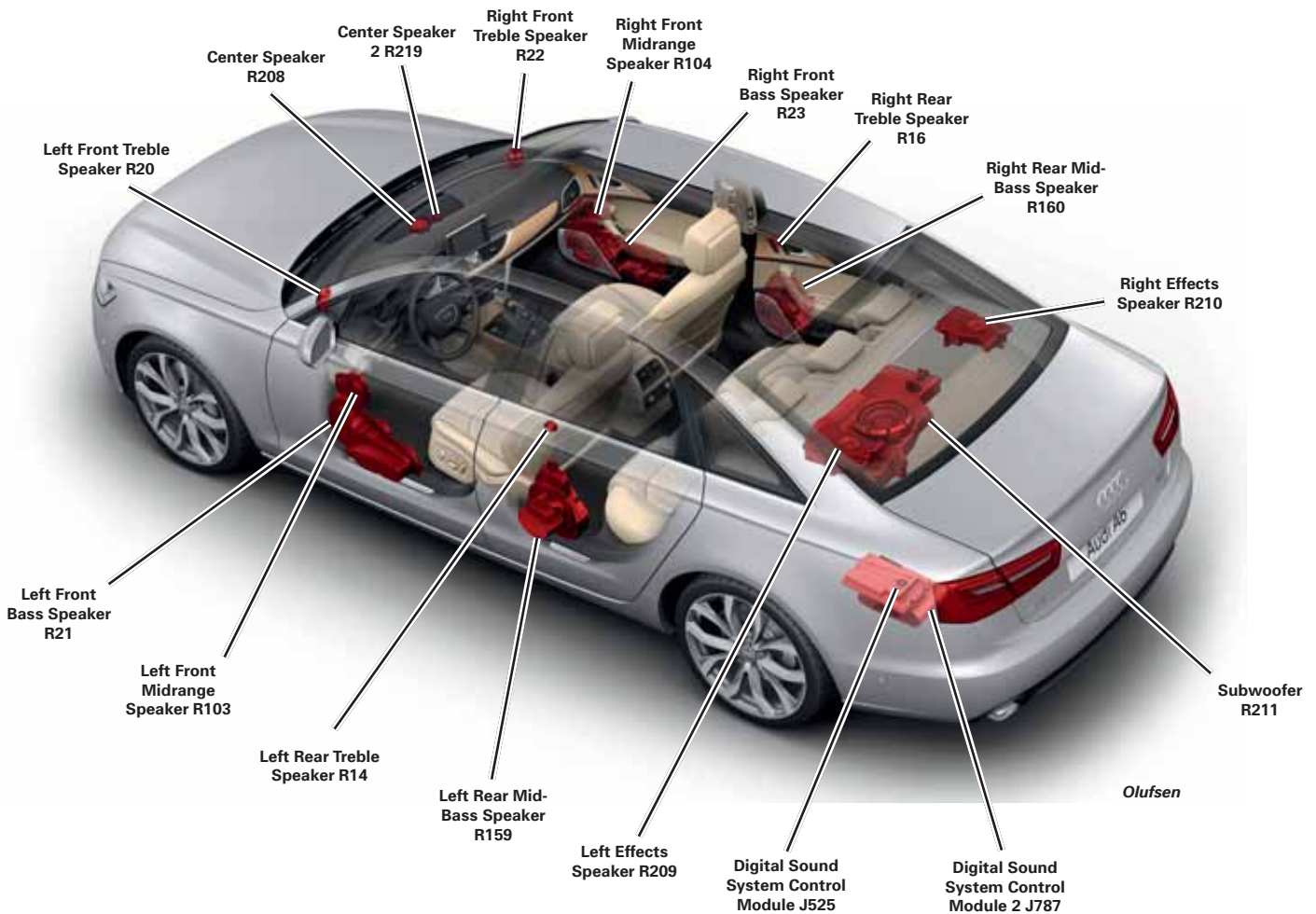

## Antenna Overview

The antennas for the A6 are located in the rear window glass and the roof. The amplifiers for the rear glass mounted antennas are located in the trunk lid.

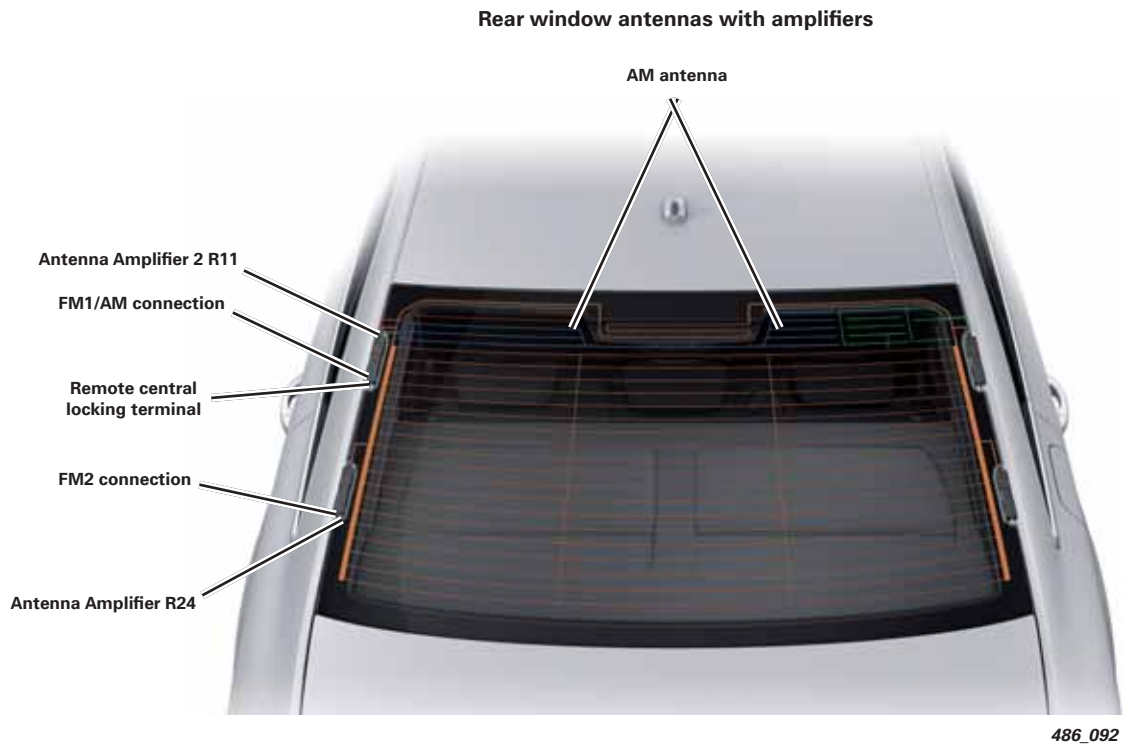
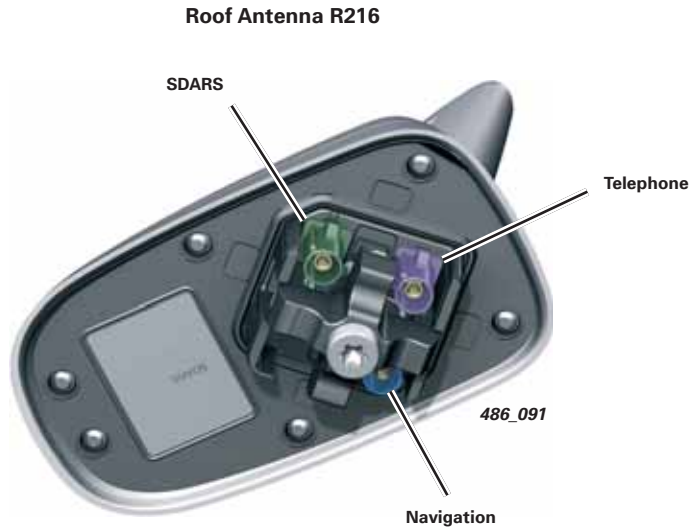

# Head-Up Display

## Introduction

The term “head-up display” describes optical systems which project information from various automotive systems into the driver’s extended field of vision.

To view this information, the driver does not have to change their head position significantly and can continue to focus on the road ahead while maintaining an upright posture. Since the driver’s head can remain “up” and need only be lowered slightly, the system is referred to as a head-up display.

The use of special windshields on models with head-up display gives the impression that the display is not actually in the windshield area, but at a comfortable distance of 8.2 ft (2.5 m) away from the driver. The head-up display appears to hover over the hood.

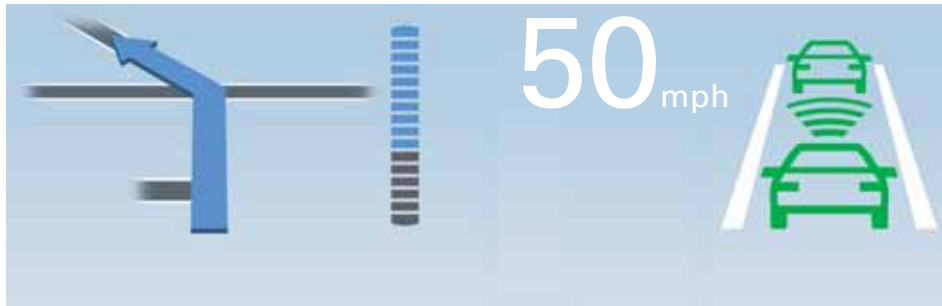

482\_002

## Viewing Advantages of Head-Up Display Over Instrument Cluster Display

- The placement of the head-up display in the extended field of vision of the driver means that the driver’s head only needs to be inclined approximately five to 10 degrees to see display data. To see similar data on the instrument cluster display, the driver’s head needs to be inclined approximately 20–25 degrees.
- As the head-up display can be seen in the extended field of vision of the driver, the human eye does not have to adapt to darker surroundings to register the display content, unlike a glance at the instrument cluster.  
This particularly applies during daylight. Adaptation of the eyes from bright to dark to register vehicle parameters and subsequent adaptation from dark to bright can be avoided.
- As the head-up display is perceived at a distance of approximately 6.5 ft – 8.2 ft (1.9 m – 2.4 m) away from the driver, the time the eye needs to focus is significantly lower than glancing periodically at an instrument cluster.

These benefits mean that desired information can be seen more easily and with greater clarity than glancing at an instrument cluster. With head-up display, driver attention to the road ahead is increased.

Use of head-up display greatly improves perception of what is happening on the road, improving overall road safety.

## Display Information

Content of the head-up display has been restricted to the most important vehicle parameters. Current vehicle speed is always shown. It cannot be deactivated in the MMI.

Other display content is only shown if activated in the MMI. Content can be activated in the MMI at the menu option "Head-up Display", then menu "Display Content".

Other content is only displayed temporarily, for example warnings, or modified system settings.

### The display can show the following content:

#### Current Vehicle Speed

Current vehicle speed is the only vehicle variable that is always displayed. This display cannot be deactivated by the driver.

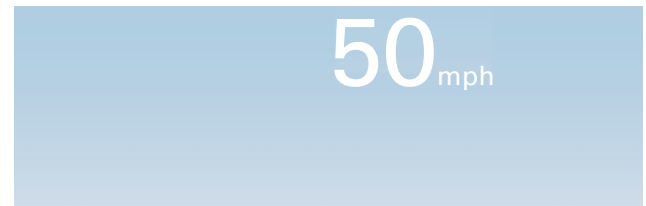

482\_003

#### Navigation Information

"Navigation Information" is only displayed when the route guidance function is active. This information must be activated in the MMI.

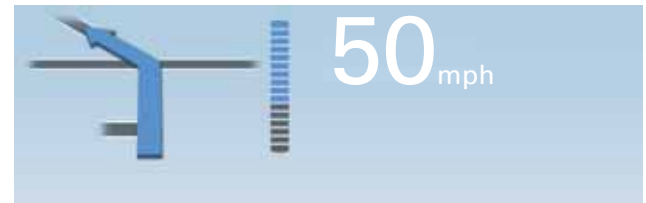

482\_004

#### Combined Display of ACC and Audi Active Lane Assist

The "ACC/Audi active lane assist" display content must be activated in the MMI.

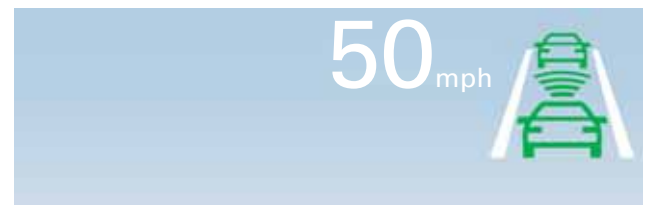

482\_005

#### Current ACC Set Speed

The set control speed of the ACC appears temporarily in the head-up display if modified. The "ACC / Audi active lane assist" display content must be activated in the MMI.

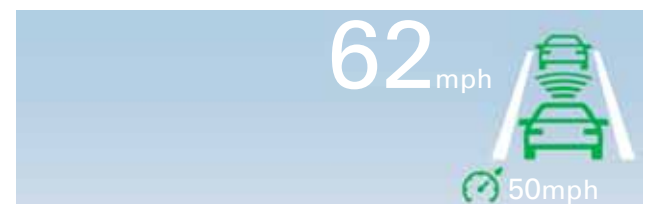

482\_006

### Current ACC Control Distance

This display appears for a short period of time if a change is made to the control distance for ACC.

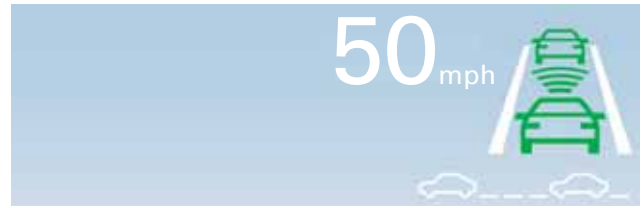

482\_007

### Audi Night Vision Assist Warning

Audi Night Vision Assist warnings can also be shown on the head-up display, once activated in the MMI.

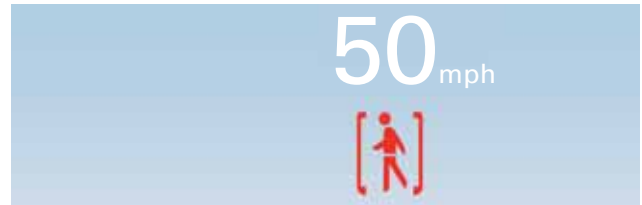

482\_010

### Red Warning Symbols

If red warning signals appear in the instrument cluster, they also appear on the head-up display. The display of red warning symbols cannot be deactivated, and are only displayed briefly. When red warning signals are displayed, all other content is suppressed except vehicle speed.

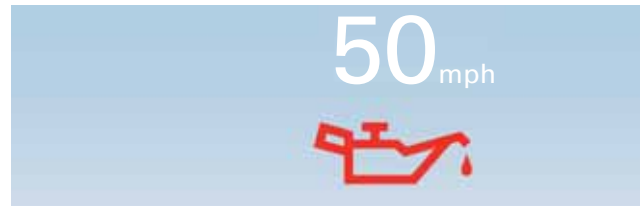

482\_011

## Windshield Projection Head Up Display Control Module J898

The central component of the head-up display system is J898. It contains all the optical, mechanical, and electrical components required for the system.

J898 is mounted in the instrument panel, directly in front of the instrument cluster.

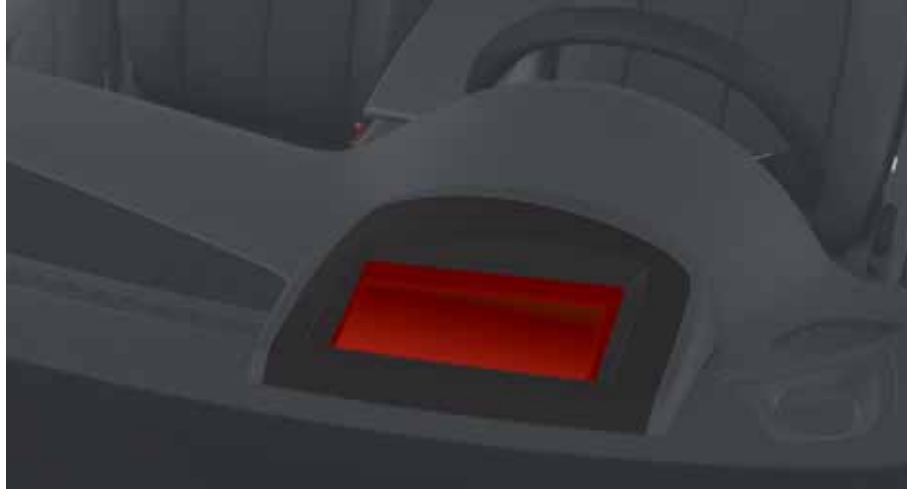

482\_012

Windshield Project Head Up Display Control Module J898



482\_013



### Note

If J898 is defective, the complete unit must be replaced. Replacement requires the removal of the windshield. For more information, refer to current technical literature.



## Optical System

The head-up display is generated by backlighting with 15 LEDs a high resolution TFT display, which is a matrix of Thin Film Transistors.

The display's function is similar to that of a slide projector. Light rays are projected via two deflection mirrors onto the windshield. One of the two mirrors is adjustable and is used for height adjustment of the display. This adapts the position of the head-up image to the seating position or body size of the driver.

The mirrors also correct any image distortion caused by curvature of the windshield.

The light intensity of the displayed image is continuously adapted to current ambient lighting conditions. To do this, Windshield Projection Head Up Display Control Module J898 evaluates luminosity values from Rain/Light Recognition Sensor G397.

The driver can adjust the brightness of the display according to their needs. This is done through the MMI and the system controls located on the vehicle light switch.

The light intensity is configured so the display also remains easily legible in direct sunlight.

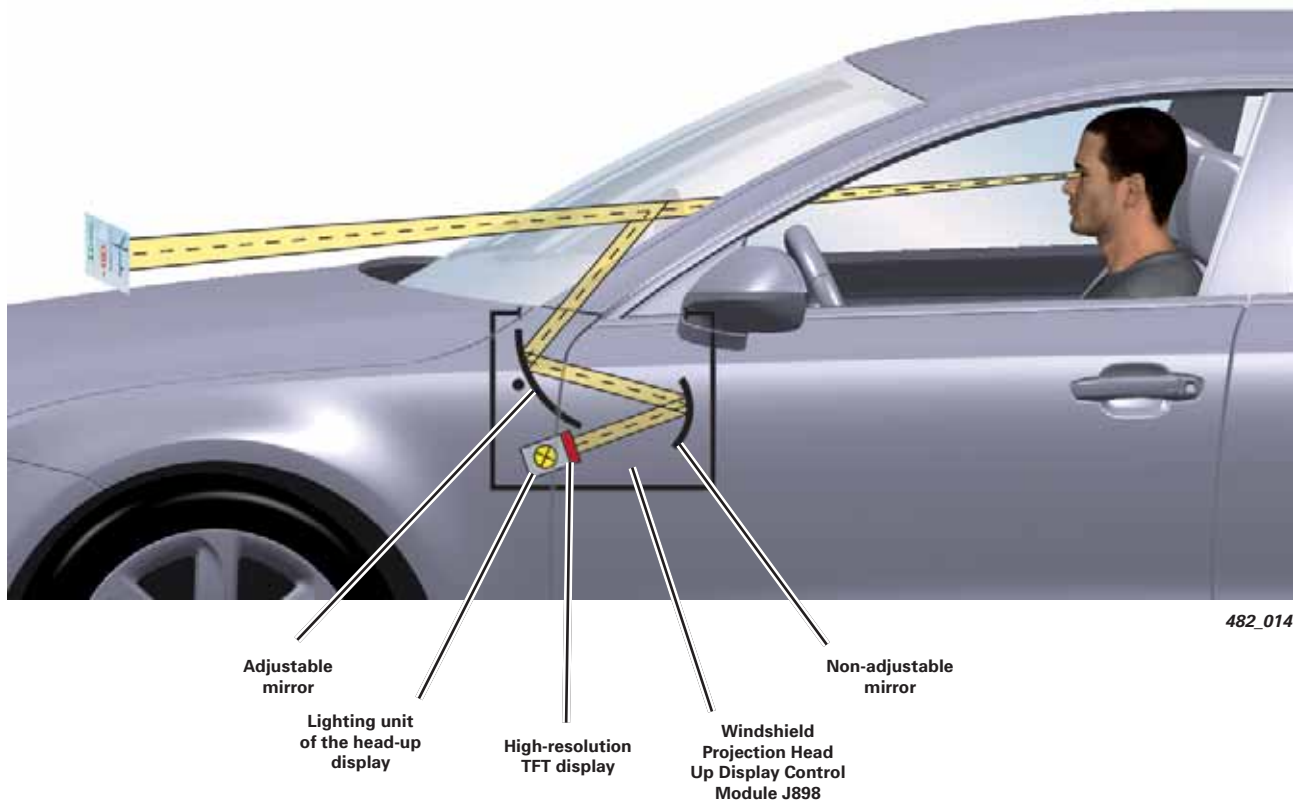

### Reference

The operation and calibration of the head-up display system for the 2012 A6 is the same as for the 2012 A7. For more details, refer to Self-Study Program 990603, *The 2012 Audi A7 Occupant Protection, Infotainment, Climate Control, and Head-Up Display*.

## Windshield

The windshield is an important optical component of the head-up display. Because the display image is also reflected by the windshield, its function represents a third mirror.

A standard windshield can create a disruptive double image.

The windshield of a vehicle with the head-up display differs from a conventional windshield in that the PVB foil (polyvinyl butyral) between the two flat glass panes of a head-up windshield is not a constant thickness.

A head-up windshield has a slight wedge shape, so the thickness of the windshield increases slightly in an upward direction. This wedge shape eliminates the potential for double images.

The tolerances for windshield installation are very tight for a vehicle with head-up display.

Windshield of a vehicle without head-up display

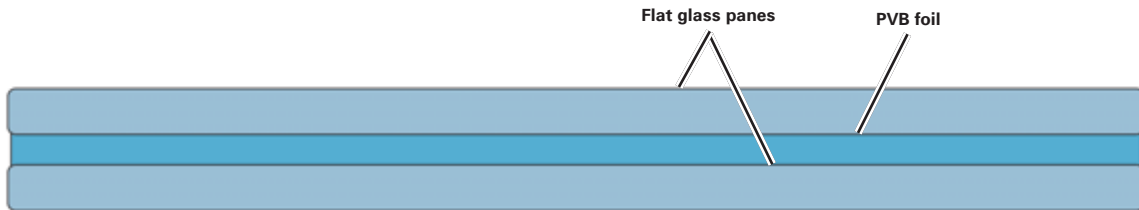

482\_016

Windshield of a vehicle with head-up display

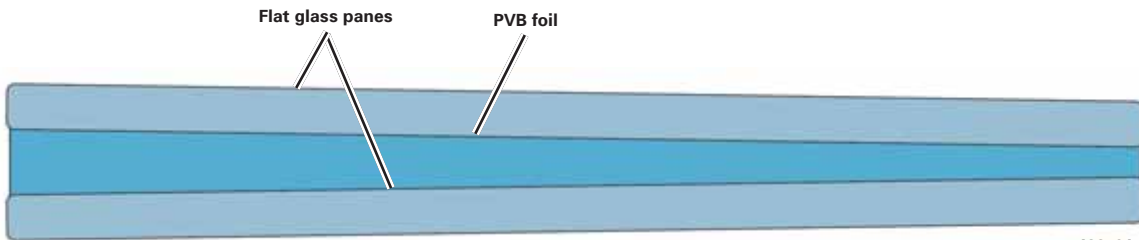

482\_015

## Electrical System

Windshield Projection Head Up Display Control Module J898 communicates with other control modules over the Display and Control CAN.

It is accessed with the VAS Scan Tool through Address Word 82.

There are six electrical connections at the control module:

- Two lines for "terminal 30"
- Two lines for "terminal 31"
- Two lines for the Display and Control CAN

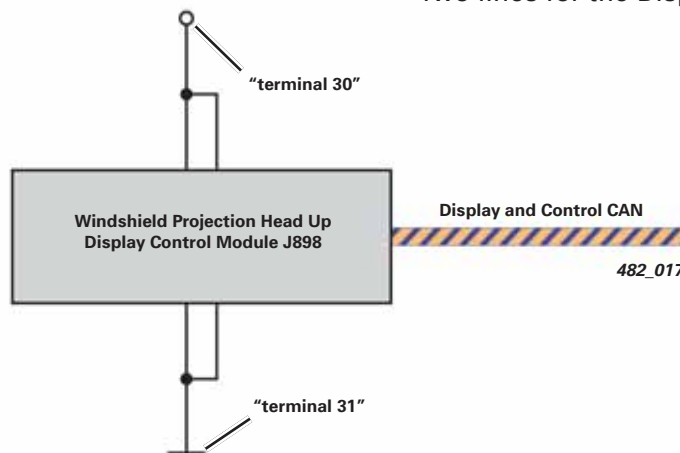

482\_017

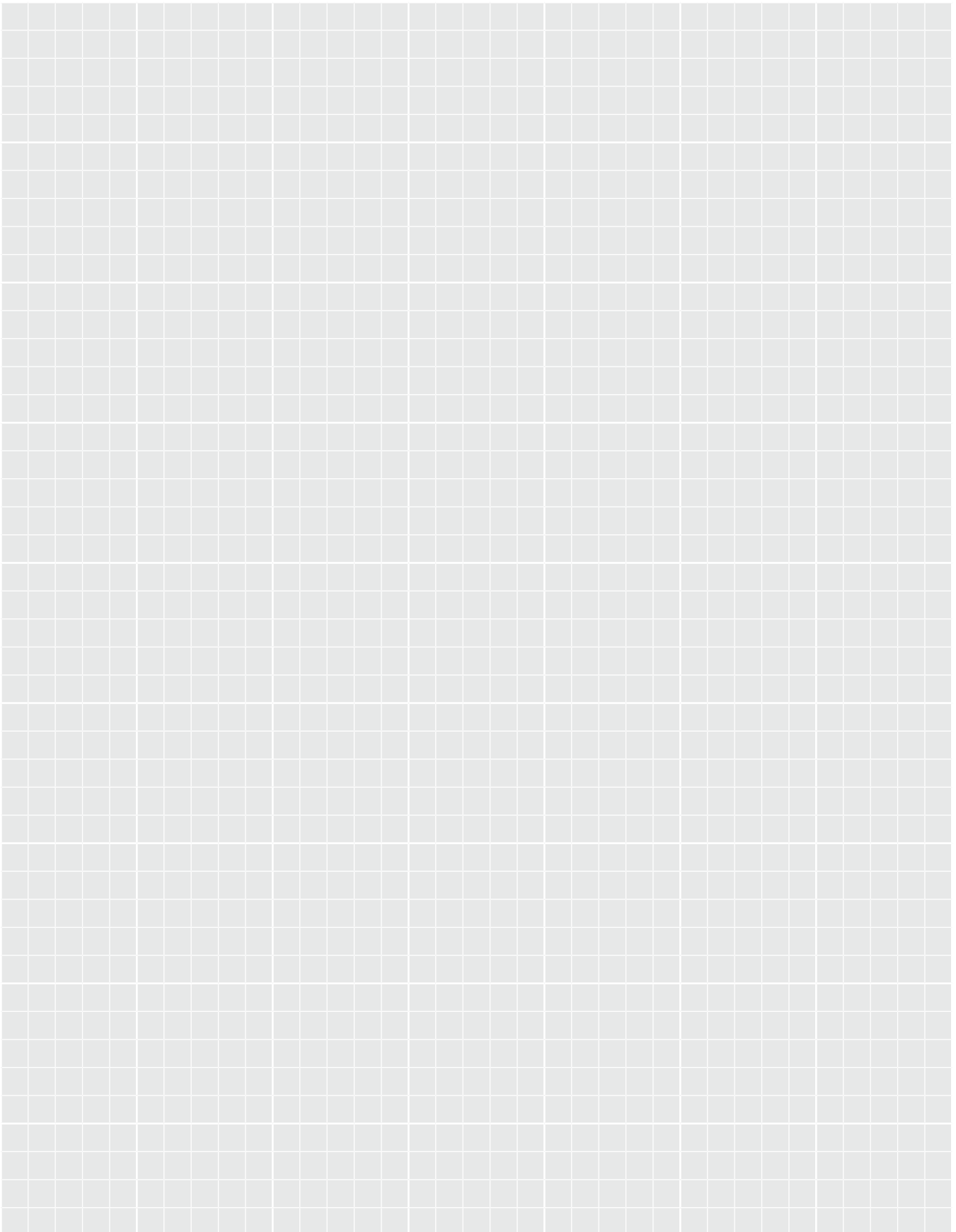

# Self Study Programs for the 2012 Audi A7

## SSP 990203 The 2012 Audi A7 Vehicle Introduction

- Body
- Occupant Protection
- Engine
- Power Transmission
- Suspension System
- Electrical System
- Climate Control
- Infotainment

## SSP 990303 The 2012 Audi A7 Running Gear and Suspension Systems

- Axles and Wheel Alignment
- Adaptive Air Suspension
- Steering System
- Electromechanical Steering
- Brake System
- ESP
- Sensor Electronics Control Module J849
- Adaptive Cruise Control (ACC)
- Wheels and Tires
- Tire Pressure Monitoring (TPMS)

## SSP 990403 The 2012 Audi A7 Onboard Power Supply and Networking

- Power Supply
- Networking
- Control Modules
- Exterior Lighting

## SSP 990503 The 2012 Audi A7 Convenience Electronics and Audi Active Lane Assist

- Topology
- Convenience Electronics
- Audi Active Lane Assist

## SSP 990603 The 2012 Audi A7 Occupant Protection, Infotainment, Climate Control, and Head-Up Display

- Occupant Protection
- Audi pre sense
- Infotainment
- Air Conditioning
- Seat System
- Head-Up Display

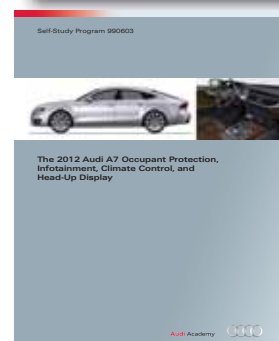
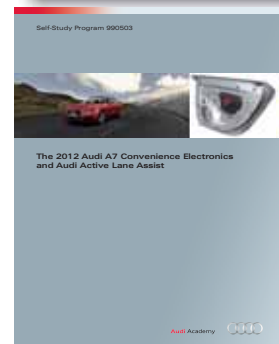
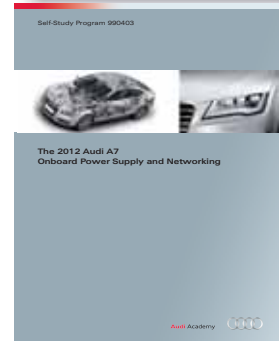
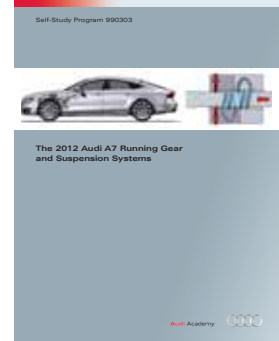
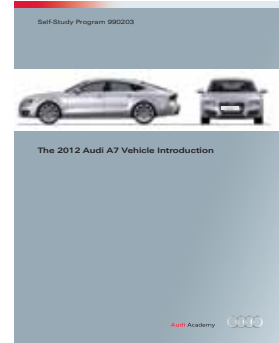

# Knowledge Assessment

An on-line Knowledge Assessment (exam) is available for this Self-Study Program.

The Knowledge Assessment is required for Certification.

You can find this Knowledge Assessment at:

**[www.accessaudi.com](http://www.accessaudi.com)**

From the accessaudi.com Homepage:

- Click on the “ACADEMY” tab
- Click on the “Academy Site” link
- Click on the “CRC/Certification” link
- Click on Course Catalog and select “990613 — The 2012 Audi A6 Vehicle Introduction”

For assistance please call:

**Audi Academy**  
**Certification Resource Center (CRC)**  
**1-877-283-4562**  
**(8:00 a.m. to 8:00 p.m. EST)**

Or you may send an email to:

**[audicrchelpdesk@touchstone-group.com](mailto:audicrchelpdesk@touchstone-group.com)**

*Thank you for reading this Self-Study Program and taking the assessment.*

Audi  
Truth in Engineering



990613

All rights reserved.  
Technical specifications subject  
to change without notice.

Audi of America, LLC  
2200 Ferdinand Porsche Drive  
Herndon, VA 20171